

9

TEAC

TD-700T

RAIN



INC

GAIN



EDS

HOLD

ENT

K

HOLD

(押L)

1

Ě†] ™ TD-700T' 3·U9b
1 ¨KDŸ?i' ½†„ž'1É› T P
" 'ÁÖ- h-% 'm"b



' m " TD-700T

V ÿi	1 Eç!&] •Áâ>¥„B hNo/ë¥ªüb
³›[/ TH h 7È÷Lb o ½ .•Ê¥¥õ¤ o ¤L È-õ¤ž¤L 0 o õ¤¤¹L	
¤Y„ 7!!È÷-WÀ ³1WïôðÒb	
ÁÕ¤YÈ÷H øì(·ªëð õ¤ b	
o 'É›È÷a T¤¹ • {Æ /{ õ¤ ¥õ¤ TH h' 'ª• ë„„-s¥l ª É ›ž'¤Lb o ¿• {Æ /{ È- ëx.È a“†{Æ /{ Ê¥q hP“à7È-b o h ùÖ ,ðÈ fLÛ›¥ÆîÊ›fLb	
hEç È»[/Æî¥¹ÄP“b o LÍÈìL^¥Æî o i <ÈÆ HÆ¥Æî o Á³áÈ .2¥Æî èÂ?È	
øì½ [/ìâïb o ÑV?çÑ „A S¶¥Æî o Ú÷ cM¥Æî o %s°¤'î ¥Æî o i“ ZÙÚ¿ 2000m¥Æî o %sÿ1£÷¥• £¥Æî ∞,^U™ê „30qx@s3 [/ìâïb o	

6-4-2." 3, Ä K´	.42	9-2-3. D/A T	.68
6-4-3.b" 3, Ä	.42	9-2-4. D/AK v È â	.68
6-4-4." 3, Ä È M´	.42	9-2-5. D/An ©k	.68
6-5. e Ä { Æ _ °	.43	9-3. í ç	.68
6-6.´ { _ °	.43	9-3-1.n´ í ç	.68
6-7. á ÿ ‹ MAU T	.43	9-3-2.! Ä´ í ç	.68
6-8. È 4" {	.44	9-4.	.69
7. 1 ! Ä	.44	9-5. 8 È HW	.69
7-1.1´ ! Ä	.44	9-6. Ö ý	.69
7-2.1 T! Ä	.44	9-7. x Ä À ì! Ä	.69
7-3.1 Z T! Ä	.46	10. TEDS Ä	.70
7-4. HH LK´ "	.46	10-1. TEDS M ÷	.70
7-5. ì ^a	.47	10-2. è TEDS	
7-6.´ •	.48		
7-7.1 { T	.48		
7-7-1.S {	.48		
7-7-2.u x {	.49		
7-8. ð í, Ä	.49		
8. û ÿ?! Ä	.50		
8-1. û T	.50		
8-1-1. •" i û	.51		
8-1-2.,´ û	.52		
8-1-2-1. í u x ç	.52		
8-1-2-2.P" u x ç	.53		
8-1-3.!´ û	.54		
8-1-3-1. í u x ç	.54		
8-1-3-2.P" u x ç	.55		
8-1-4. Ü (´ û	.56		
8-1-4-1. í u x ç	.56		
8-1-4-2.P" u x ç	.57		
8-1-5.,,´ û	.58		
8-1-5-1. í u x ç	.58		
8-1-5-2.P" u x ç	.59		
8-1-6.,,!"´ û	.60		
8-1-6-1. í u x ç	.60		
8-1-6-2.P" u x ç	.61		
8-1-6-3.´ { Ä M î OKH ¥ U è	.62		
8-1-6-4. HH LK´ ì" H ¥ U è	.63		
8-2. p Ü (´ ¥ Q"	.64		
8-3. y î •" T	.64		
8-4. " † û T	.65		
8-5. CLEAR	.65		
8-6. u x ç	.65		
8-7. 1 î, Ä	.65		
9. " d! Ä	.66		
9-1.! Ä i %	.66		
9-2. D/A Đ	.66		
9-2-1. D/A Ä	.67		
9-2-2. D/A ñ	.67		

1-1. - ë ð



A !Â¿f

S AIN

É¿Vu7áy«MAUb

CAL

É¿VÉ›©r{Æn b

FNC

'·U9AU"´H¿/N¿f u7ÿ?'

†b

'!ÂÄëu7H¿/N¿f ÷¿ÿ?|b

'÷¿!Â´H¿/N¿f "÷¿¥~|

l"Äb

GAIN

É¿VÉ›L= €n b

-EDS

'õª TEDS.Ë H É¿Vu7 TEDSn

Äëb

5b

Ê4!Â["„÷¿!Â´b

g t

÷¿îAU¥Äëb

'!ÂÄëu7H¿/N¿f Ê4!Â["

„!Â´¥Ê"b

B HOLD/EN¿f

É¿V î ûÿ?¥ Tb QÉ¿N¿f V
ì" ûÿ?b

÷¿!Â´H¿/N¿f V´a!Â[" !Â

´ -ªMÄ/B["b

C ZE O/ESC¿f

'n´íç¹ OFFH É¿N¿fVP",Ä
Ü™ÿ?(» 38:)b

'n´íç¹ ONH ¿/N¿fV<Ä|.U
9"´!Â¹, "3,Äÿ? b

' ûH ¿/N¿fVb" û´b

'!ÂÄëu7H¿/N¿f V_ MîB)'

†b

o]HÉ¿ ESC„ ENT¿f V " ì"¿o

íçÿ?b

D AUà

·U9"´„!Â´É›AUb

ÂT.Ë {ÆsÈ ·U9"´íEžÈAU

| C[/n · b

ŠLOAD:A/D Đ µÑ

LOAD:A/D Đ žÑ

ŠFULL:AUµÑ

(l¿KIAU´)

FULL:AUžÑ (v¿KvAU´)

ŠOVER FULLÆÑ Kv{ÆS¶ (µ´)

OVER FULLÆÑ Kv{ÆS¶

1. †q „ÿ?

1-2. ^aë ð

o

4

2'

1-3. .Ë •|{Æ ã

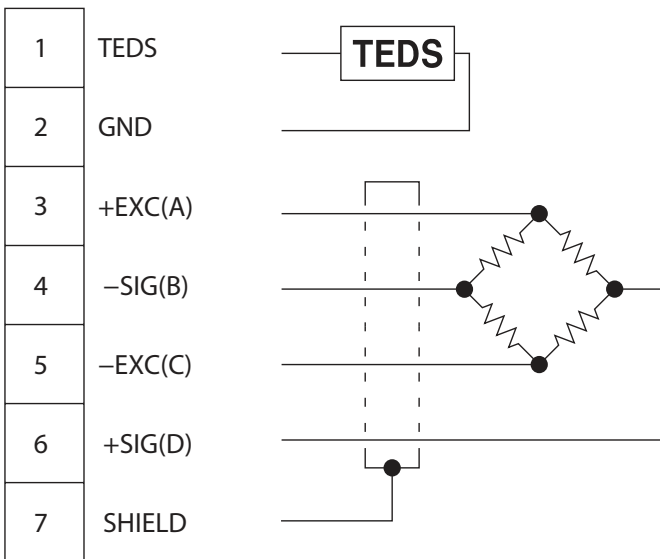

TD-700T, !û * e . Ë b
 Â T ã = Â TEDS Æ . Ë | 1 î É › n b

0 l	•	L ä
1	TEDS (F)	í ä
2	GND (G)	s ä
3	+EXC (A)	£ ä
4	ŠSIG (B)	' ä
5	ŠEXC (C)	j ä
6	+SIG (D)	â ä
7	SHIELD (E)	Û ä

o L ä ^ ' ³ Å / ¥ ‹ M Ë T . Ë î P ¨ ¥ • L
 ¥ p ä b

1-4. D/A { ã

1-5. e Å • | { Æ 0

01 	•	a ü
12	CLEAR	

1-7. Åë Æm

αΥË÷

ö Åë

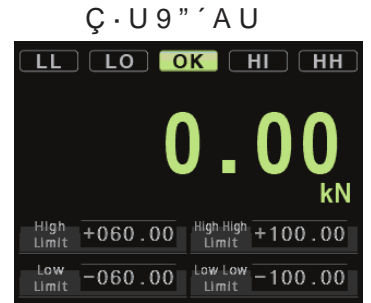
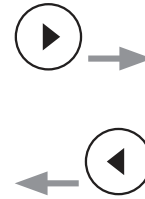
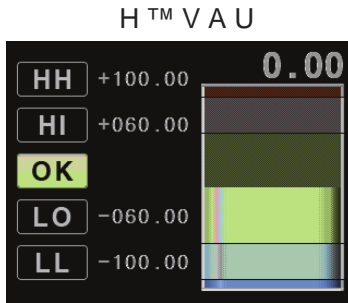
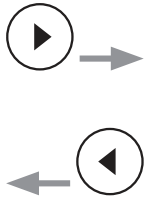
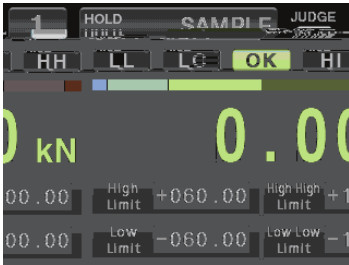

1-8. Åë

!!πΥÈ÷ªöÅëu7b

P" g „ t ¿f÷¿Åëjmb

1-8-1. öÅë

" K„//KH

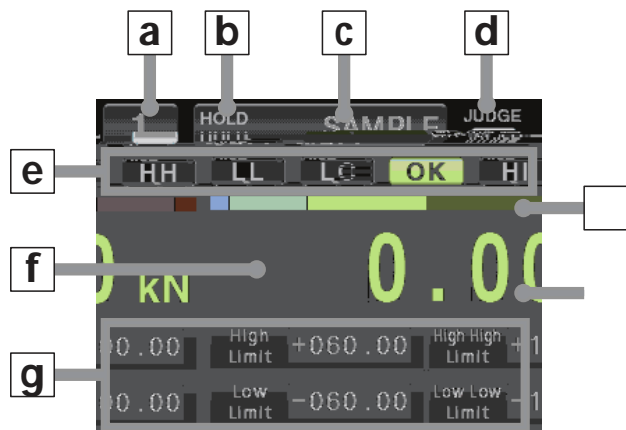

a i% I|
AU'-Êç¥i% ¥I|b

■ û·U§
' ûÿ?µrH HOLD3"¥/ë Cää
·U§b'uxçl ûÿ?µrH Cçä·
U§b

c ûÿ?!Â
AU'-Êç¥ û Tb

d '·U§
' { µrH N·U§M¹ääb
'·| "¹ ONH ' JUDGE{Æ 0¹
ONHN·U§¹ää ' JUDGE{Æ 0¹ OFF
HN·U§¹'äb
'·| "¹ OFFH N·U§SÔ¹ääb

e ' Ê~
HH/HI
ft·U§Ä [L·U9"´vç
K„ K¥!Â´¥' { TÉ>AUB

OK
'·U9"´vç ©ç/KiO©ç lç
KH N·U§Ä [LAU OK' {
Tb

LL/LO
ft·U§"ç ·U9"´lç//K„/
K¥!Â´¥' { TÉ>AUB

ÿd
' { îTô 1 Ta1 { T„ìª
!Â?3MÄb
·Uè¹¹ T!Â¹ LL/LO/OK/HMHa 1
{ T¹oS { p[#ìª!Â¹ 0H¥î
TUèb

■ ·U9"´

g Ka/Ka K[#//K¥!Â´
AUò!Â´b
ÂTì" K„//K |AUíç!Âb

■ H™V
NH™V¹·U9"´¥ EVUb
YVKvAU´!Â H™V S¶¥KÚ´É>!
Âb
ÂT//K„/K¹, Úç, H™V|V,À
KvAU´É>AUB
ÂT//K /Klç, H™V|,T¹ï·´
É>AU AUS¶|VKvAU´ÀµKvAU
´b

■ †Ê

j íç!Â
N)AUíç ÿb
CAL:n´íç
SET!Â´íç
KEY:çoiç
' " K„//KH |, Cftíçb

2. 1/2

и v f t „ ç | TD-700T 1/2 e Å ë ð b

2-1. 1/2 e Å ë ð

1 и v e Å ë ð 1/2 7 g № ' j m e Å ë ð 7 d b

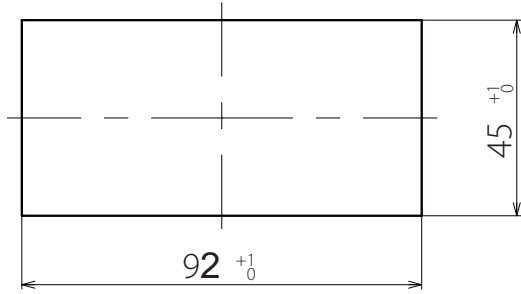

o y p e Å ë ð " 1 0.8-5mm

2 . / P a . e Å ë ð % ç C b
~ î V î 5 h P ù Ö ' ! ! №] H | Ä ñ 5
h _ ! ! a † Á î b



- o '|eÅëð%çC w_eÅëðH h£ÜÉ
 ›½ i' ½ 1%7Àµ©...•wb
- o ' 5hÇç„eÅëð%çC ¥5hP
 “VñĪ1%1õ¤ ½ ›ª|eÅëð%çC
 ¥5h_!!wî 'aXÜ| íçb
- o ÂT5hÇç„eÅëð%çC ¥5hÃ1%
 õ¤ i û fÕ ÿ/ 5hV?M•w ,
 a†'!!¥Ççb

ÿi

- o øì|'!!!½ ;° aÑ Ñ 0-40°C S¶
 A Ñ 35-85 S¶¥Æî €%s@¿
 ¥Ñ MÄ„ Ī`¥Æîb
- o øì|'!!!½ f i ç ã — ¥Æî
 €|È0íq]¿µ]ÄÐÖ ªKÿ 8©Æ
 îb
- o '½ ñ Â=†H h' Ú£],!!
 =†ÑV 40°C b
- o øì|'!!!½ V 'î ¥Æîb

2-2. VeÅëð ."

- 1** ./Pa·eÅëð%çC b
 ~î Vî5hP ùÖ'!!¥]H |Ãñ5
 h_!!ª†Áîb

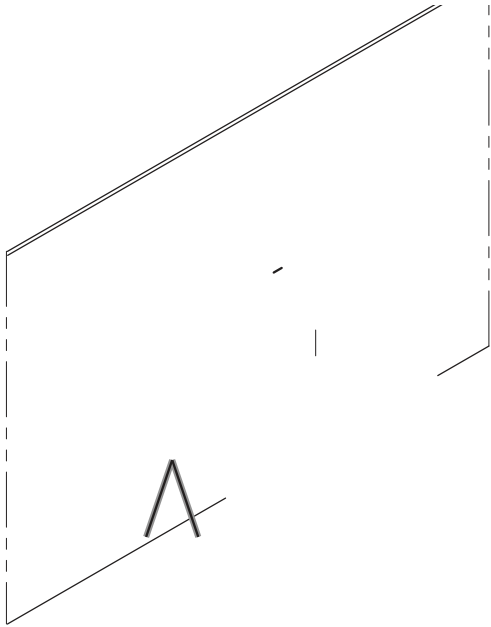

2-3. ½ À DIN • E

1 |'!!¥ª†¬Æ **DIN • E** ½ a¥ b
V©iBëÔ ¬Æ [L^„ç 2 î³¥Z_b

ÿi

h' |½ a¥ ¹%½ À'!! Àµ©...
•wb

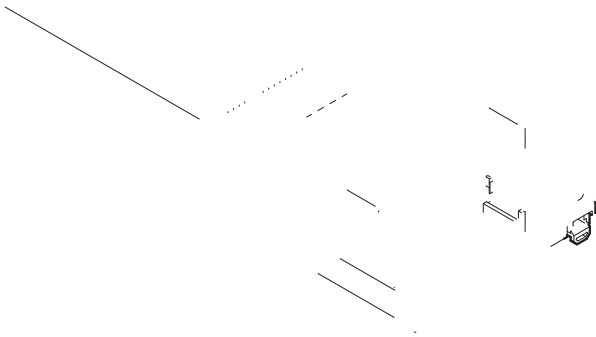

2-4. VDIN • E . "

1 u7½ a¥ ¥Vî5h _-~î'
!!| V **DIN • E . "** b

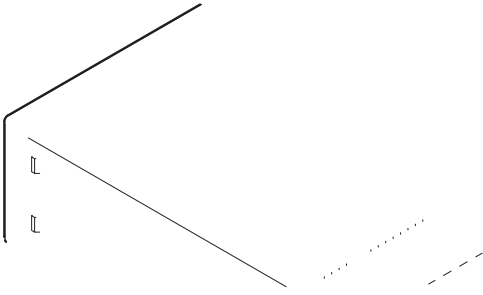

5 ^ ^ ~ î • L [L ' a • L X 1 % 1 C Æ d
ï b

6 X | ð ñ À . Ë ª | ñ h ñ Æ • U 9
i P ¨ „ ´ | % ç b

3-1-2. e Å • | { Æ / { ð ñ

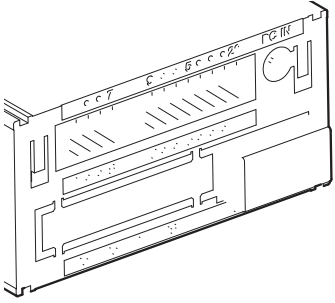

3-3. õ ¢ È ÷ {Æ 0

3-3-1. ° @ È ÷

° @ È ÷ {Æ È â ‹¹ 12...24 V

h P ¨ 0.517...2.081 m (20...14 AWG) È ÷ L b

'õ ¢ ž 0 † H h P ¨ â ¢ 0 M3 z , v

¿ 6mm b

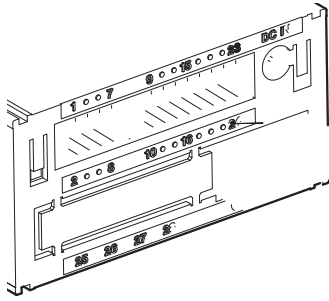

3-4. 0

'|©BeÅ{Æ 0,, COM 0-W ^ 7^H
 YV"+{ÆÈ^{|Æ•|b
 (Ä„d(Ä Ø 5 TTL"È 7^ úVÁ3 ^b

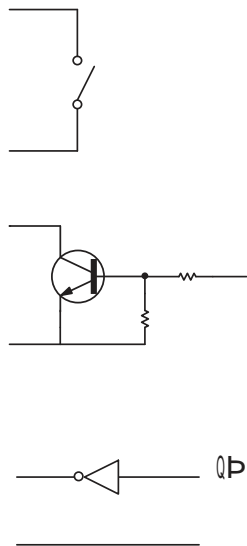
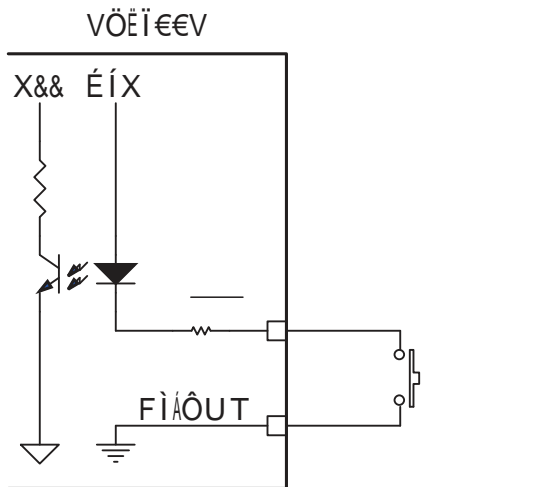

4-1. ' T

1 / FNC / f u7ÿ?'†b

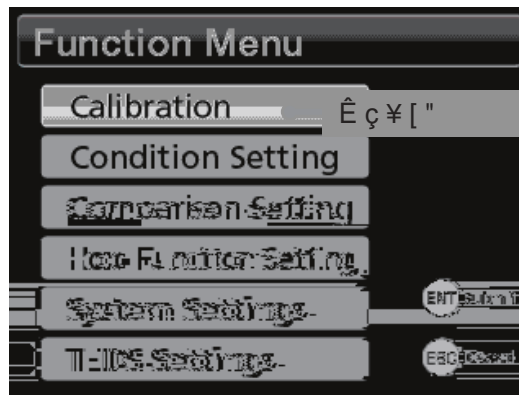

2 P" 5 „ b / fÉ4!Â[" -ª /
 EN. / fu7!ÂÄëb

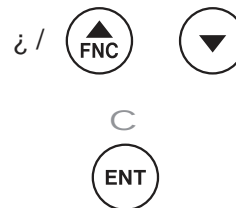

ÂT BñÄë i V ¥È[³1AU
 V¥ät / ,†| C 5/b bMîÀ 5 b
 Vu7/BÄëb

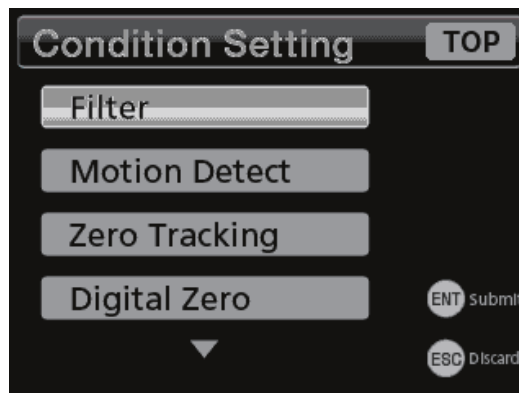

'Ê4n q ©r{Æn H | C[/Âëb

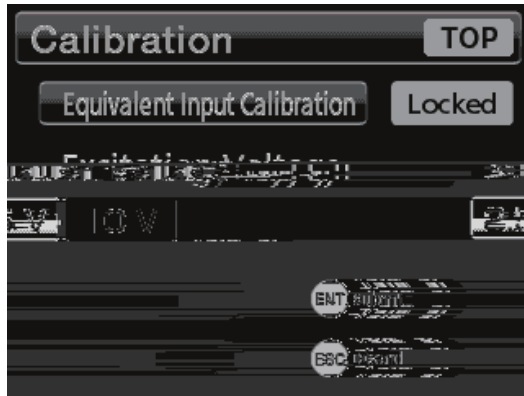

3 ÷ ¿ B" !Â´b

ô ,]¥'†[" V?ö CB" !ÂÂëb
 '¿/ ENT¿f'ª!Â´H |u7/B!ÂÂ
 ëbô » 23:¥o 4-7.!Â´† Vpí¥n
 Hq!Â„ ûÿ?!Â¥½ K@)!Â¥!
 ÂÂë|¿½GQu7b
 ÂTí³÷¿!Â´h¿/ ENT¿fMÀ/B!
 ÂÂëb
 èÂ ©r{Æn ¥ff/ |ªõ C[/
 ¥!ÂÂëb

ãÈà
 -ç{
 -ç,
 ,ÄÜ™
 D/A { T
 D/A KvÈâ
 Ê4©r†Ê
 n´íç

!Â›îª ÿ?´†Âëu7b
 o ¿/ ESQ¿f Rí B)Âëb

4-2. VÊ[ïÊ4!Â´

'-´1âä ßb
 ðÊ[¹çä ßb



P¨g „ t ¿f÷¿Êç¥Ê[-ª¿/ ENT¿
 fb'i ñÊ[Ê4B›ï¥K. ¥Ê[H
 ¿/ t ¿f|Ê4/B›KP ¥Ê[b
 XÜª¥["|Ú säAUb

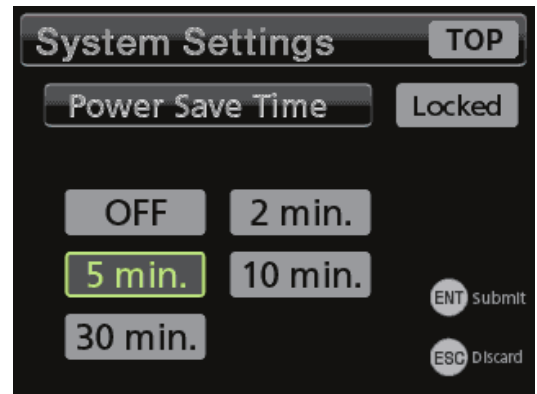

4-3. {Æ”‘T!Â’

Êç¥”3ää ßÀAUB



P”g „ t ÷ ÷ Ê4 P” 5 „ b ÷ ÷

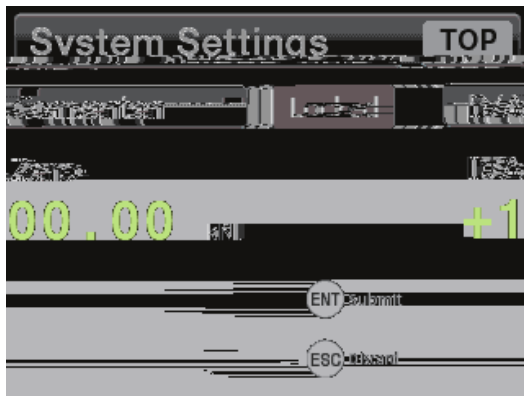

4-4. ÷ ÷ |”ÄÊÂ

Ç V ÷ ÷ -TÆ€ €ZPöÀÜ@|@i;

1 MTàs°E1 öÀÜ@|@ É`z ;ðòç ÷ f A U
o 0 pb

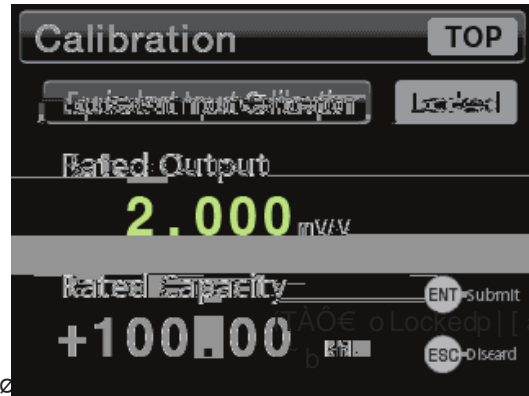

2

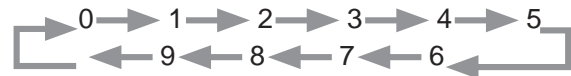

3

ÿi

Â¹ ON /BQ7 !!!H|ë¹ a´b
-> itÀ , -a`n
Ä itÀÔ€ oLoc
'XÜö¤ TEDS.Ë H ÂTn ´itÄ!

4-5. itÀ

Vì, ÷ ÷ n ´, !Â´b

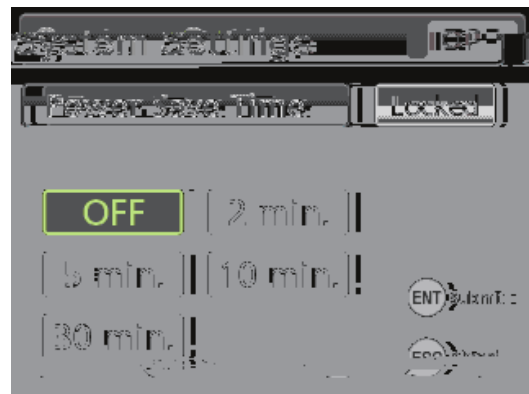

itÀÔ€ì ú0opkòò !@ Æ€U`oð³di X`üj @ò æ@Ò



1 ç!Â¥• h• » 26 :¥o 4-8.!Â´
Vp b

4-6. R íöÂë

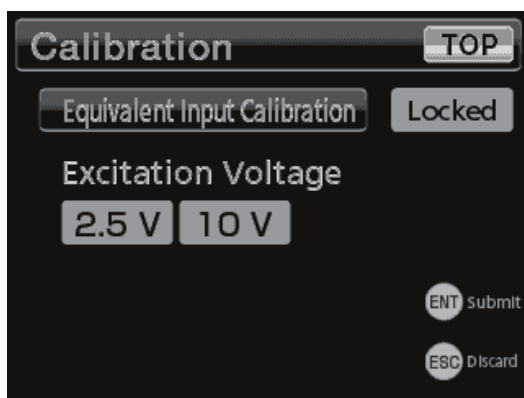

P" g „ t ç fÊ4 TOP -ª ç / ENT ç f V R í
öÂë b

4-7. !Â´† V

4-7-1. ÿ?´†

- † ÿ?´†
- Calibrationn (» 31 :)
- Condition Setting H q !Â (» 39 :)
- Comparison Setting1 !Â (» 44 :)
- Hold Function Setting û ÿ ? !Â (» 50 :)
- System Settings d !Â (» 66 :)
- TEDS Settings TEDS !Â (» 70 :)

4-7-2. n

- n — Equivalent Input Calibration r { Æ (» 33 :)
 - n — Bridge Voltage B â
 - Rated Output/Rated Capacity - ç { / - ç ,
 - Zero Balancing, Ä Ü™
 - D/A Output Mode D/A { T
 - D/A Max. Voltage D/A K v È â
 - Select EU Ê 4 © r † Ê
 - Cal. Value Lockn ´ í ç
- L = € n (» 35 :)
 - Bridge Voltage B â
 - Zero Balancing, Ä Ü™
 - Rated Capacity - ç ,
 - D/A Output Mode D/A { T
 - D/A Max. Voltage D/A K v È â
 - D/A Full Scale D/A ; ñ
 - Select EU Ê 4 © r † Ê
 - Max. Disp. Value K v A U ´
 - Cal. Value Lockn ´ í ç
- TEDS n (» 36 :)
 - Rated Output/Rated Capacity - ç { / - ç ,
 - Zero Balancing, Ä Ü™
 - Select EU Ê 4 © r † Ê
 - Cal. Value Lockn ´ í ç
- Select Min. Grid Ê 4 K I W i (» 37 :)
- Select Disp. Time Ê 4 A U Q ” (» 37 :)
- Max. Disp. Value K v A U ´ (» 38 :)
- Select EU Ê 4 © r † Ê (» 38 :)

4-7-3. H q ! Â

H q ! Â

- Filter r o (» 39 :)
 - Select LPFÊ 4 ® Y r o
 - Select Num. of Moving AvgÊ 4 M î Ü (' ¥ ”
- Motion Detect î ÿ • © (» 40 :)
 - Time H W
 - Width z
- Zero Tracking, Ä õ 6 (» 41 :)
 - Time H W
 - Width z
- Digital Zero ” 3 , Ä (» 42 :)
 - Enable Digital Zero ” ” 3 , Ä
 - Digital Zero Limit Value’ 3 , Ä K ’
 - Clear Digital Zerob ” ” 3 , Ä
 - Digital Zero Offset Valueè 3 , Ä Ê M ’
- Control Input Checke Å { Æ _ ° (» 43 :)
 - D/Z
 - HOLD
 - JUDGE
 - CLEAR
 - SEL1
 - SEL2
- Judge Output Check’ { _ ° (» 43 :)
 - Judge Output Check’ { _ °
- Static Strain Disp. Modá ÿ ‹ M A U T (» 43 :)
- Select Data OutputÊ 4 ” { (» 43 :)

4-7-4. 1 ! Â

1 ! Â

- Comp. Value Settingl ’ ! Â (» 44 :)
- Comp. Pattern Settingl T ! Â (» 44 :)
- Comp. Mode Setting1 Z T ! Â (» 46 :)
- HH LL Limit EnableHH LLK ’ ” (» 46 :)
- Hysteresisì a (» 47 :)
- Judge Signal’ • | (» 48 :)
- Comp. Output Pattern1 { T (» 44 :)
- Nearly Zero æ í , Ä (» 49 :)

4-7-5. û ÿ ? ! Â

û ÿ ? ! Â

- Hold Mode û T (» 50 :)
- Times of Averagep Ü (’ ¥ Q ” (» 64 :)
- Fast Sampling Modeÿ Î • ” T (» 64 :)
- External Hold Mode“ † û T (» 65 :)
- CLEAR SignaCLEAR | (» 65 :)
- Zone Definition u x ç l (» 65 :)
- Auto Zero 1 î , Ä (» 65 :)

4-7-6. " d ! Â

" d ! Â

- Setting Memory ! Â i % (» 66 :)
- D/A Converter D/A Đ (» 66 :)
 - D/A Zero D/A , Ä
 - D/A Full Scale D/A j ñ
 - D/A Output Mode D/A { T
 - D/A Max. Voltage D/A K v È â
 - D/A CAL TEST D/A n © k
- Lock í ç (» 68 :)
 - Cal. Value Lock n ´ í ç
 - Setting Value Lock Â ´ í ç
- Brightness (» 69 :)
- Power Save Time È H W (» 69 :)
- Languages Ô ý (» 69 :)
- Reset to the Factory Settings Â À (» 69 :)
 - ì ! Â

4-7-7. ED S ! Â

TEDS ! Â

- TEDS Data Change TEDS' ÷ ¿ (» 70 :)
- Restore TEDS Data TEDS' (» 71 :)
- TEDS Data TEDS' (» 72 :)

4-8. !Â´ V

4-8-1. n

["	!Â	ìT	†ÊAU	a´	!ÂS¶ / Ê[n´ íç	!Â´ íç	!Â´ i%
TEDS calibration TEDSn	Rated Output - ç {	A U	mV/V		0.300-3.200			
	Rated Capacity - ç,	A U	1 î		00000 - 99999			
	Zero Balancing, Ä Ü™		î!Â¥ †Ê		³ ›			
	Select EUÊ 4 © r †Ê	Ê [N	N, kN, Pa, kPa, MPa, kg, sht, ton, mN · m, N · m, kN · m, í			
	Cal. Value Lockn ´ íç	Ê [OFF	OFF, ON			
Select Min. GridÊ 4 K I W ï		Ê [1	1, 2, 5, 10			
Select Disp. Times Ê 4 A U Q ”		Ê [Q ”	4	4, 6, 10, 20			
Max. Disp. Valuk v A U ´		{ Æ	î!Â¥ †Ê		00000 - 99999			
Select EUÊ 4 © r †Ê		Ê [N	N, kN, Pa, kPa, MPa, kg, sht, ton, mN · m, N · m, kN · m, í			

4-8-2. H q!Â



4. !Â

["	!Â	iT	†ÊA U	a'	!ÂS¶ / Ê[/ T	n' íç	!Â' íç	!Â' í%
Control Input Check e Å {Æ _ °	D/Z	A U			LOW, HIGH			
	HOLD	A U			LOW, HIGH			
	JUDGE	A U			LOW, HIGH			
	CLEAR	A U			LOW, HIGH			
	SEL1	A U			LOW, HIGH			
	SEL2	A U			LOW, HIGH			
Judge Output Check ' { _ °		Ê[HH, HI, OK, LO, LL			
Static Strain Disp. Mode á ÿ ' M A U T		Ê[OFF	ON, OFF			
Select Data Output Ê 4" {		Ê[!A U ¥{	û ' Ð A U ']„{ , {Æ ° α{ b			

4-8-3. 1 !Â

["	!Â	iT	†ÊA U	a'	!ÂS¶ / Ê[n' íç	!Â' íç	!Â' í%
Comp. Value Setting 1 ' !Â	High high limit input {Æ K {Æ (HH)			999.99	-99999-99999			
	High limit input K {Æ (HI)			150.00	-99999-99999			
	Low limit input / K {Æ (LO)			100.00	-99999-99999			
	Low low limit input // K {Æ (LL)			50.00	-99999-99999			
Comp. Pattern Setting 1 T!Â		Ê[LL/LO/OK/LO/OK/HH/HH	OK/LL/LO/LO/HH, LL/OK/LO/LO/HH, LL/LO/OK/HH/HH, LL/LO/LO/HH/OK			
Comp. Mode Setting 1 Z T!Â		Ê[S Ô 1	S Ô 1 × ç ù W 1 " α í , Ä - " 1 " α í , Ä - " × ç ù W 1 û ù W 1 ì " 1			
HH LL Limit Enable HH LLK ' "		Ê[ì "	ì " "			
Hysteresis ì ^a		{Æ	!Â ¥†Ê	000.00	00000-99999			
Judge Signal ' •		Ê[ì "	ì " "			

["	! Â	ï T	† Ê A U	a ' ! Â S ¶ / Ê [n ' í ç	! Â ' í ç	! Â ' í %
Comp. Output Pattern 1 { T		Ê [S {	S { a u x {		
Nearly Zero α í , Ä		{ Æ	î ! Â ¥ † Ê	001.00	00000-09999		

4-8-4. û ÿ ? ! Â

4. ! Â

["	! Â	ì T	† Ê A U	a ´	! Â S ¶ / Ê [n ´ í ç	! Â ´ í ç	! Â ´ i %
Lock í ç	Cal. Value Lock n ´ í ç	Ê [OFF	OFF, ON			
	Setting Value Lock ! Â ´ í ç	Ê [OFF	OFF, ON			
Brightness		Ê [S		OFF, À , S ,			
Power Save Time 8 Ê H W		Ê [OFF	OFF, 2 min., 5 min., 10 min., 30 min.			
Languages Ô ý		Ê [° Ô		° Ô ‡ Ô			
Reset to the Factory								

5-1. $\hat{\mu} \neq n$ ZE Z \neq , \neq

$\mu \neq \hat{\mu}$ n ZE $\odot r \{ \neq n a L = \neq n \}$,
 TEDSn bn -, n^a $\hat{\mu} \neq n$ ZE $\hat{\mu}$ i
 M] \neq , \neq b
 n \neq $\hat{\mu}$ • $\hat{\mu}$ / b

$\hat{\mu}$ n \neq \neq
 "d! $\hat{\mu}$ q \neq q n \neq \neq $\hat{\mu}$ 4 OFF

C

n
 n q $\odot r \{ \neq n$
 L = $\neq n$
 TEDSn

C

n \neq \neq !

n5 n -, n^a | 1³ \neq , \neq $\hat{\mu}$ \neq $\hat{\mu}$ b -
 $\odot r \{ \neq n a L = \neq n \}$, TEDSn $\hat{\mu}$ \neq a
 $\hat{\mu}$ b

5-1-1. n \neq $\hat{\mu}$ \neq \neq , \neq $\hat{\mu}$
 YÈ P³ !!H|n \neq \neq ! $\hat{\mu}$ ¹ ONbn -
 n \neq \neq A \neq ! $\hat{\mu}$ ¹ OFFbn^a Q|n \neq \neq ! $\hat{\mu}$ ¹ ONb

1 \neq / FNC \neq f u7 \neq ? '†b

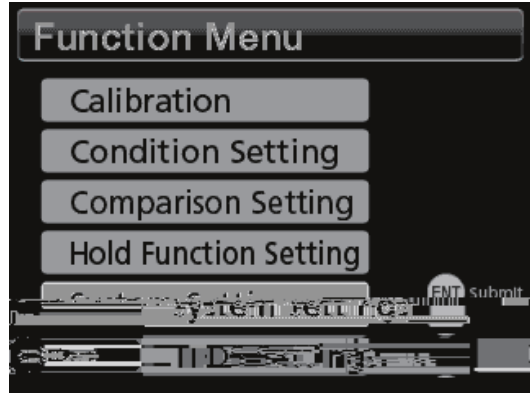

2 P⁵ b \neq f \neq $\hat{\mu}$ 4 -^a \neq v "d! $\hat{\mu}$ q \neq \neq " $\frac{1}{2}$ $\hat{\mu}$ \neq $\hat{\mu}$ b

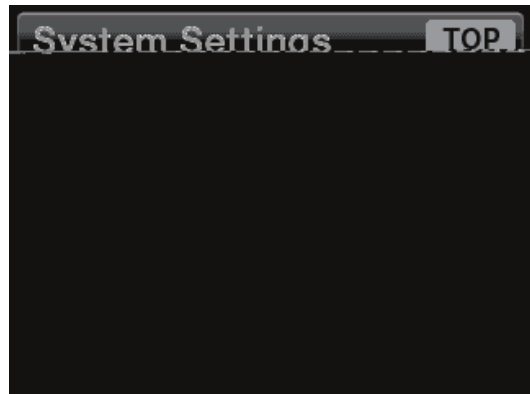

C

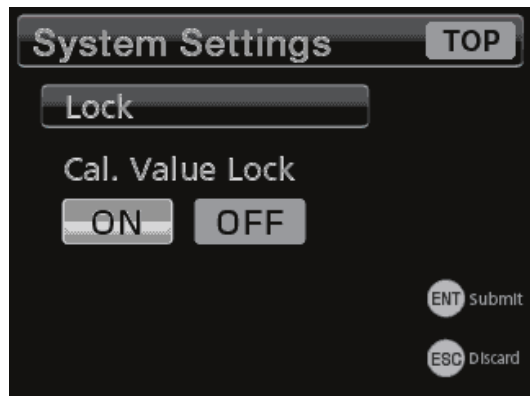

3 P" g t ÿfÊ4 OFF ON b

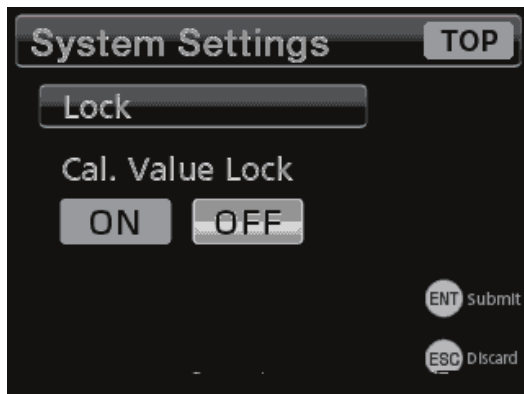

4 ÿ / ENL ÿf'aÊ4 b

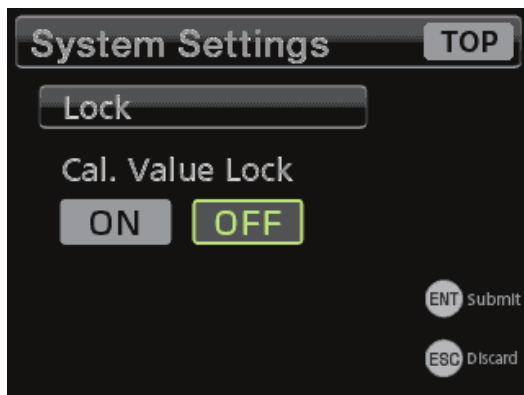

5 ÿ / ESC ÿf| !Â T b

ÿi
 o ZERO ÿf¥ÿ?ô n 'íç!Â¥,]7ò
 s b
 'n 'íç' ON H ÿ / ZERO ÿf VP""
 3,Äÿ?b'n 'íç' OFF H ÿ / N ÿf
 VP",ÄÜ™ÿ?b
 o '],i"÷ÿn ' h n a|n 'í
 ç!Â¹



OFF OFF

5-3. L = € n

YV|L = €@Fž.Ě Ě›n b

B â

C

,ÄÜ™

C

-ç, € n

C

D/A { T

C

D/A KvĚâ

C

D/A j ñ

C

Ě4©r†Ě

C

KvAU´

C

n ´íç!Â

o 1 çD/A!Â¥• h• » 66:¥o 9-2. D/A
Đ pb

5-3-1. B â

Ě[2.5V, 10V

Ě4 ‹MĚT.Ě Ě¥Bâb

ç/ ENTçf÷çBâb

o T¹¨ç!ÂBâ¥ Inž.Ě ¥{ |

9v |KvĚâ!Â ,ÑV.Ě ©k²TV

¥Kv ãĚâ¥S¶=b

ÿi

ÂT!Â ÑV.Ě Kv ãĚâ¥ ñ¨´.

Ě V?âĚb

ÿd

o a¹ 2.5Vb

o TEDS Ĩ ´ | TEDS H ÂTBâ¥!

ÂvçTEDS% î:c¥Kv ãĚâ |ÜB

â÷ç¹|çKv ãĚâ¥ ñ¨´b

5-3-2. ,ÄÜ™

.Ě í €H ç/ ENTçfb

,ÄÜ™ùW | Cz É›ĭ• 3gb›î,

ÄÜ™ª C/B„ç¥!ÂÂëb

o ÂT Cn p hçvp • • |M‹n

@b

5-3-3. -ç, € n

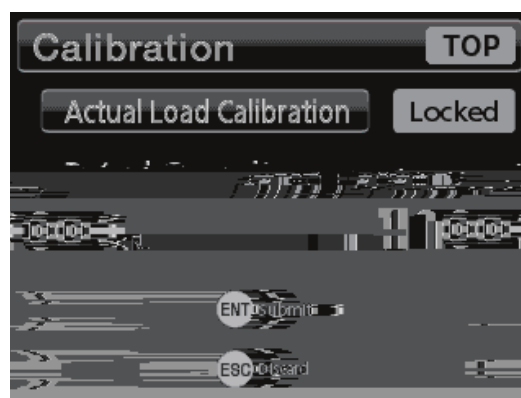

!ÂL = €´i³› €n b

L = ¥ €@Fž.Ě H ç/

ENTçfb

© .Ě { a ´a-ç, b

Â T C n p h ç v p • • | M < n @ b

ÿ i

| - ç , ! Â 1 D/A j ñ ' b

ÿ d

o N) ! Â ¥ | " Ä Ê Â | \$ " ÿ T 1 . U 9 " ' ¥
 | " Ä Ê Â b
 o 1 ç D/A ! Â ¥ • h • » 66 : ¥ o 9-2. D/A
 Ð p b

5-3-4. D/A { T
 Ê [Ê â Ê @

5-3-5. D/A K v Ê â
 S ¶ • 1..• 10 ([1 V 1 9)

5-3-6. D/A j ñ
 ' @ F o 9-2-1. D/A, Ä p ! Â ' H | { o 9-2-4. D/A
 K v Ê â p ! Â ' Ê â (') ç Ê @ T H 1 20 mA) b

ÿ d

1 ç D/A ! Â ¥ • h • » 66 : ¥ o 9-2. D/A
 Ð p b

5-3-7. Ê 4 © r † Ê
 Ê 4 < . U 9 " ' ¥ † Ê b

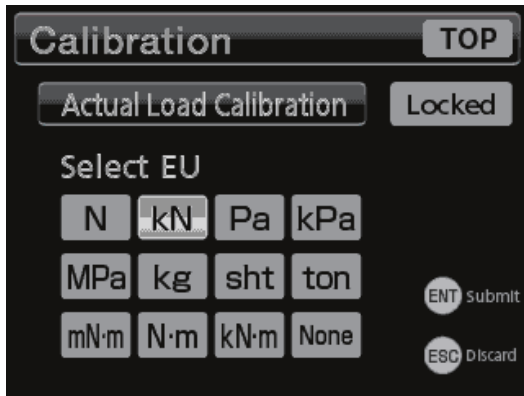

Ê [N, kN, Pa, kPa, MPa, kg, sht, ton, mN · m, N · m, kN · m,
 none

5-3-8. K v A U '
 ! Â î A U ¥ K v . U 9 " ' (» 38 :) b

5-3-9. n ' í ç
 1], i " ÷ ç n ' Y Ê < | n ' í ç ! Â
 1 O N b

5-4. ED Sn

TEDS. Ê | " - ç { „ - ç , ¥ n • i
 % i % ï b

TEDSn | N n • [L 1 î : c n ' b
 o Ê ç TEDS f í 3 Ê 4 ý ? ' † ' V u 7 TEDSn
 Â ë b

- ç { / - ç , A U

ç
 , Ä Ü ™

ç
 Ê 4 © r † Ê

ç
 n ' í ç ! Â

5-4-1. - ç { / - ç , A U
 | TEDS " a | A U - ç { / - ç , b

ED Sn ù W î A U ¥ - ç , " 3

TEDS. Ê - ç ,	† Ê	. U 9 " ,
1	N, kN	01.000
2	N, kN	02.000
3	N, kN	03.000
4	N, kN	04.000
5	N, kN	005.00
10	N, kN	010.00
20	N, kN	020.00
30	N, kN	030.00
40	N, kN	040.00
50	N, kN	0050.0
100	N, kN	0100.0
200	N, kN	0200.0
300	N, kN	0300.0
400	N, kN	0400.0
500	N, kN	00500

ÿ d

o 'È ÷ ð YH | 1î | TEDS b
 o N)!Â ¥ -ç, | "Ä Ê Â | \$ "ÿ T¹ · U
 9 " '¥ | "Ä Ê Â b
 o D/A!Â | î¹ Â /!Â b
 D/A { T È â
 D/A Kv È â 10V
 o | Kv AU ' !Â¹ -ç, ¥ 110%b

ÿ i

| B â !Â¹ | ÿ TEDS % ï î i % ¥ Kv ã È
 â ¥ ñ " ' b

5-4-2. , Ä Ü™

. È í € H ÿ / ENT ÿ f b
 , Ä Ü™ ù W | C ž É › ï • 3 g b › î ,
 Ä Ü™ª C / B „ç ¥ !Â Â ë b
 o Â T C n p h ÿ v p • • | M < n
 @ b

5-4-3. Ê 4 © r † Ê

Ê [N, kN, Pa, kPa, MPa, kg, sht, ton, mN · m, N · m, kN · m, 4 Ä ð Ö · U 9 " ' î A U ¥ Q " b
 none
 Ê 4 ‹ · U 9 " ' ¥ † Ê b
 o Â T õ ð = Â TEDS . È | !Â | † Ê b

5-4-4. n ' í ç

¹], i " ÷ ÿ n ' Y È ‹ | n ' í ç ! Â
 ¹ ON b

ÿ i

Â T n ' í ç¹ ON ' ! ! ð Y È ÷ H | , ö
 ? 3 1 î n b

5-5. Ê 4 KI W ï

! Â · U 9 " ' K I ¥ " 3 M Ä b



Ê [1, 2, 5, 10

5-6. Ê 4 A U Q "



Ê [4, 6, 10, 20

5-7. K v A U ´

! Â î A U ¥ K v · U 9 " ´ b

^a ! Â 1 - ç , ¥ 110%b

Â T Ñ V N " ´ | C o • FULL: Plus Value Over (Over

Max. Disp. Value) +/- FULL ž ´ Ñ (



6-1. ro 6 .



6-3. ,Äõ6

Nÿ?1îõ6,ÄÎM,, ð¥,ÄvMb
 P",Äõ6 ',ÄMî,v¿!Â¥z H ·U9"´|1îØœžò!ÂHWWi¥,Äb
 Ç'n´íç!Â¹ ONiO "3,Ä!Â¹ ONH Nÿ?œ T"b
 ÂT HW!Â¹ 0.0ðio z !Â¹ 0.0 ,Äõ6|, T"b

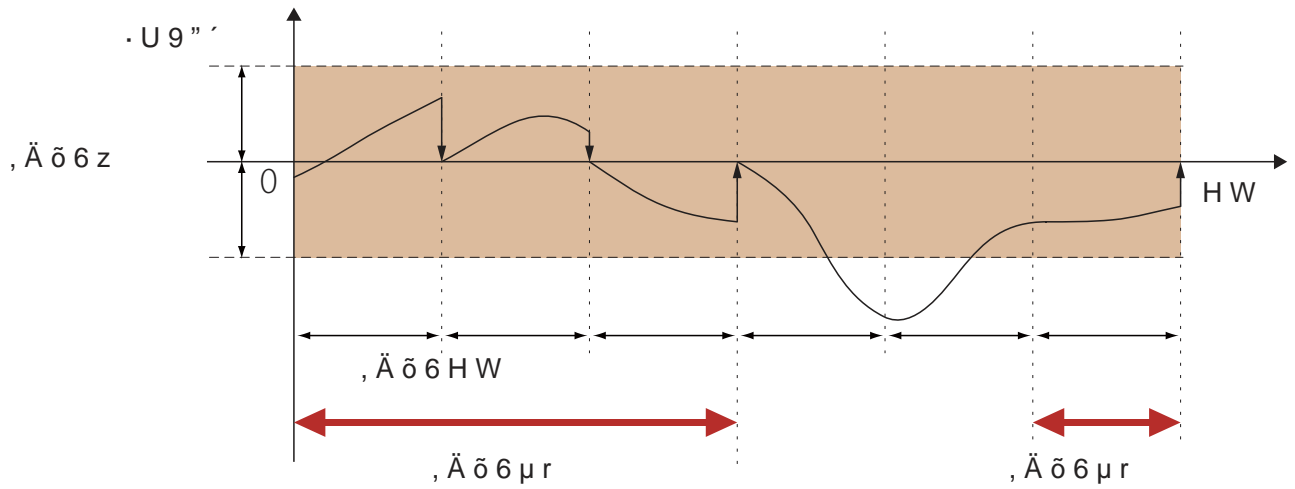

6-3-1. HW



6-3-2. z

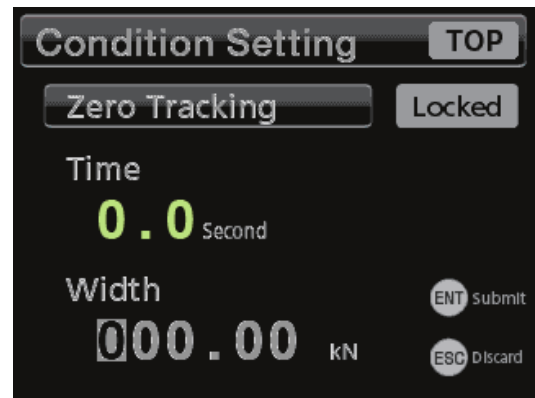

6-4. "3,Ä

6-4-1. "3,Ä

'|"3,Ä!Â1 OFF É¿ ZERO¿f |
eÄ{Æ 0¥ D/Z!Â1 ON H |,3)"3,Ä
ÿ?b

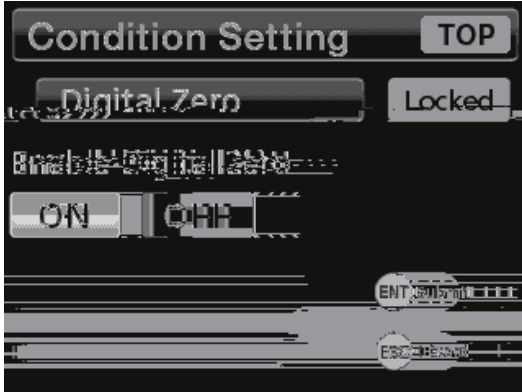

6-4-2. "3,ÄK'

!Â"3,Ä} ¥S¶b !Â'¥†ÊÐ·U9"
'¥†ÊM]b



ÿi

ÂT'-.Ë {Æ'ÑV"3,ÄK'¥!Â' |
Co Digital Zero Limit error("3,ÄK'p) i
O·U9"',M1,b
|"3,Ä!Â1 ON H ÂT|n 'íç!
Â1 OFF 'PÉ¿ ZERO¿f |eÄ{Æ 0¥ D/
Z!Â1 ON 9,3),Äÿ?b

ÿd

ÂT³>b)"3,Äÿ? '-.Ë {Æ'Ð,
ÄÜ™"AU1,b

6-4-3. b"3,Ä

|•"3,Äî³>¥AUØæîð [L QA
UÄÜØæ¥"b
3),ÄÜ™a "AU1,b

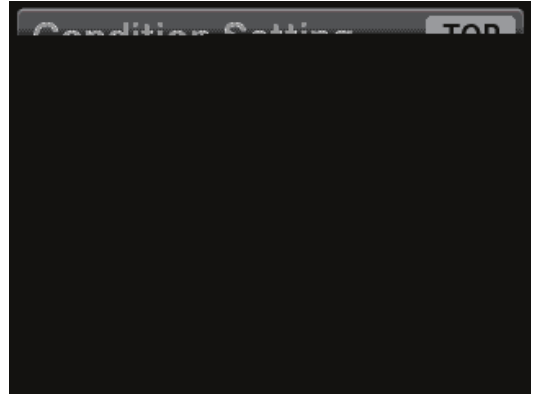

6-4-4. "3,ÄÊM'

!Â'V·U9" Äx ïh€b

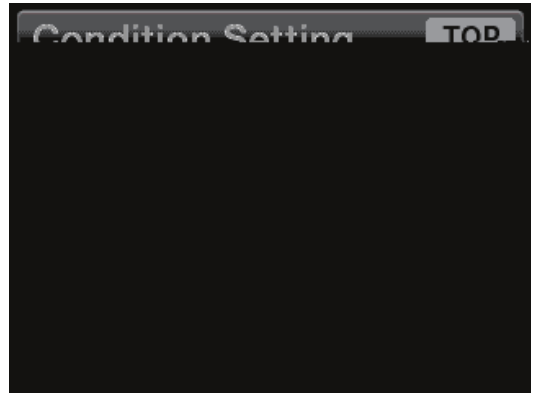

6-5. eÅ {Æ _ °

ô {Æ•|¥,] AU LOW (OFF) HIGH (ON)



6-6. ‘ { _ °

V|Bñ‘ { Ê[M¹ ONb

³>‘ { ¢L_°HP”b

ÿiNH,T¹·U9É>îTb

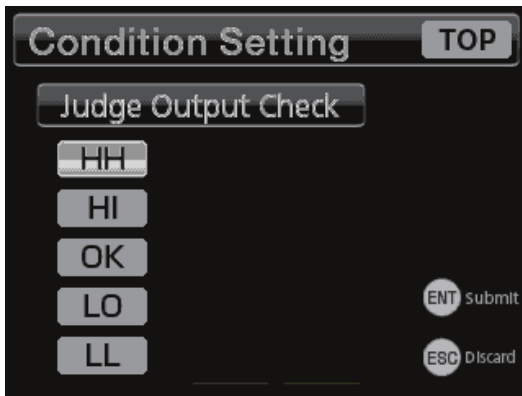

Ê 4 HH, HI, OK, LOLL | ¼ [" ¥ ‘ { M¹ ONb

6-7. áÿ<MAU T

!Â^Ž•”<M †Ê (0ST)AU{Æ•|b

_°.Ë { „·U9”´¥, xçÿH “

.Ë „È- [# µsÉ>ØæHP”b

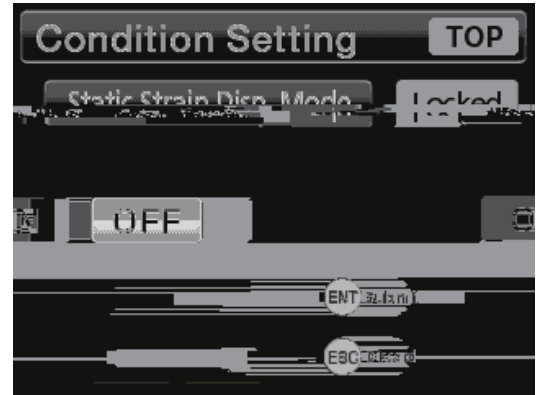

ÿ d

o ¿ / ESC¿ fV | áÿ<M T b

o P”<M ””¹ 2.0¥1 ñ<M Ë ¥ Z E A U áÿ< M b

6-8. Ê 4” {

Ê 4 D/A Ð ¥” { b

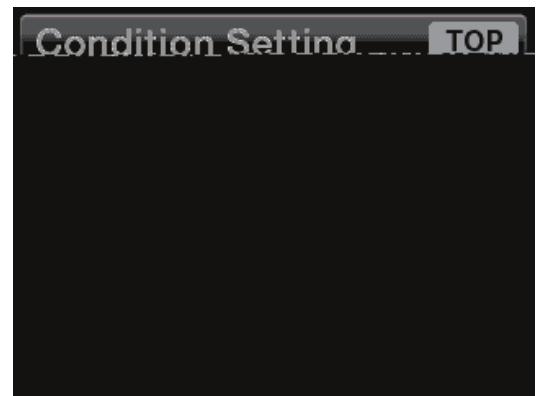

Ê 4” { µ [/ ÖÊ [b

û´ÐAU´],, { b

|{Æ°¤ { b

7. 1 !Â

7-1. 1 '!Â

P" Nÿ?!Â Ka/Ka K,,//K' Đ.
U9"É>1 i|ò1¥' { M' ONb

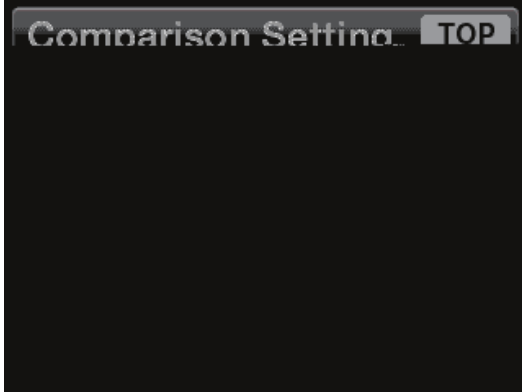

o '| HH LLK' " !Â'1" H íE ÷ ÷ HH,,
LL'b
HH: K'
HI: K'
LO: /K'
LL: //K'

ÿi
//K' < /K' < K' < K'
ÂT, i@ •Hq | Co Error message (p •
) iO!Â' íE\$'ab{Æi@ •Hq¥"
-a ÷ / ENT ÷ fb

ÿd
V " ì" HH,, LLK'b
P" 5 ,, b ÷ f ÷ ÷ Ê4 i Âë·§Ê4 HH LL
" HH LLì" -a ÷ / ENT ÷ f !ÂÉ'ab

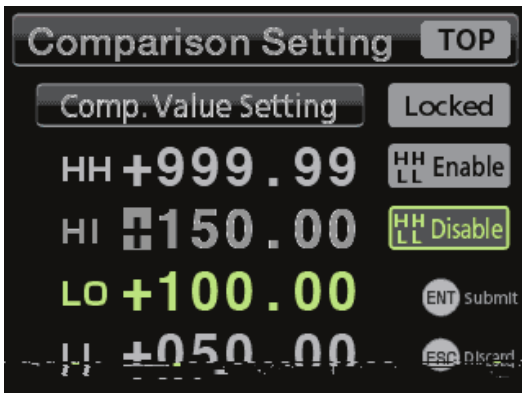

7-2. 1 T!Â

V ÷ ÷ HH, HI, LQ LL¥' { K,, /Ks¥b



Ê[
OK/LL/LO/HI/HH
LL/OK/LO/HI/HH
LL/LO/OK/HI/HH
LL/LO/HI/OK/HH
LL/LO/HI/HH/OK

'!Â' LL/LO/OK/HI/HH, ñ' { s¥ó K
ñ' { s¥ó/K (YÈ¥1 { T!Â
H)

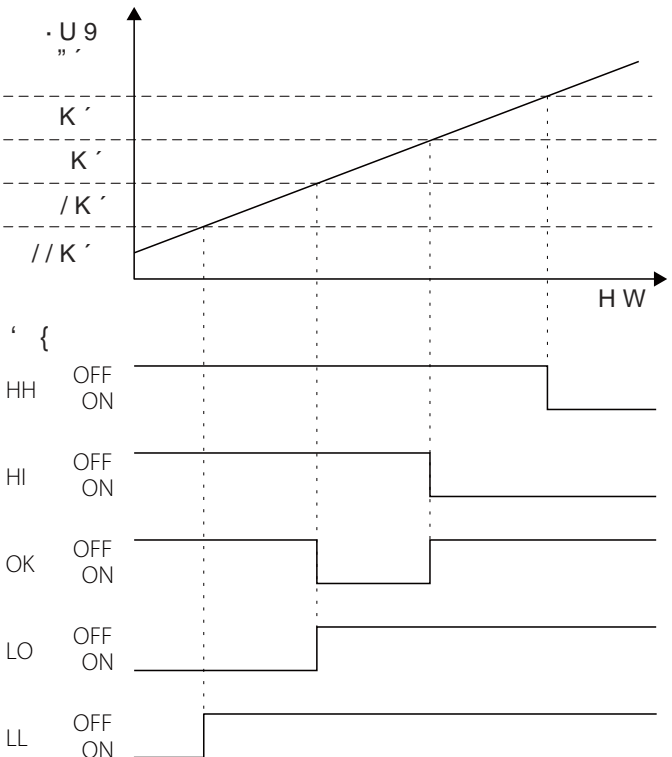

'!Â' OK/LL/LO/HI/HH ††' { ũs¥ó
 K YÈ¥1 { T!ÂH))
 H

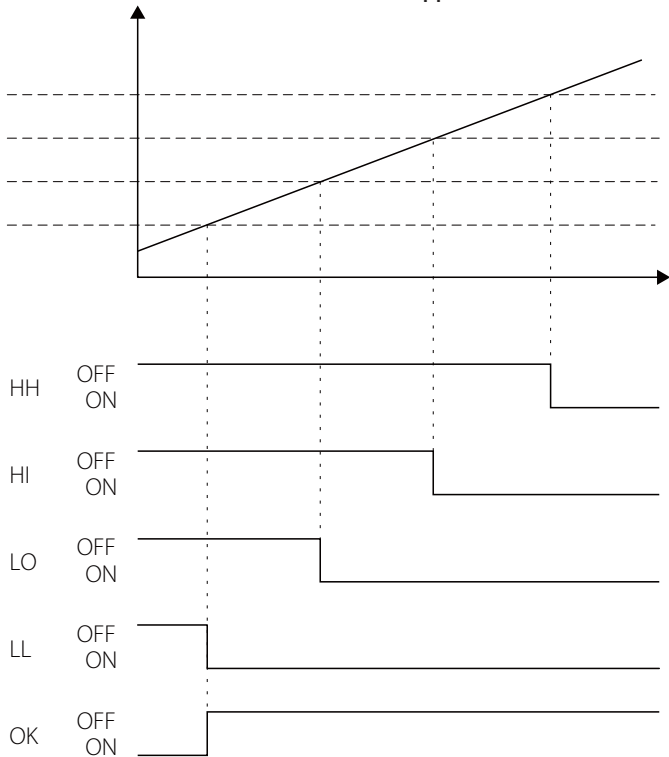

'!Â' LL/OK/LO/HI/HH, Øñ' { s¥ó K
 Bñ' { s¥ó/K (YÈ¥1 { T!Â
 H)

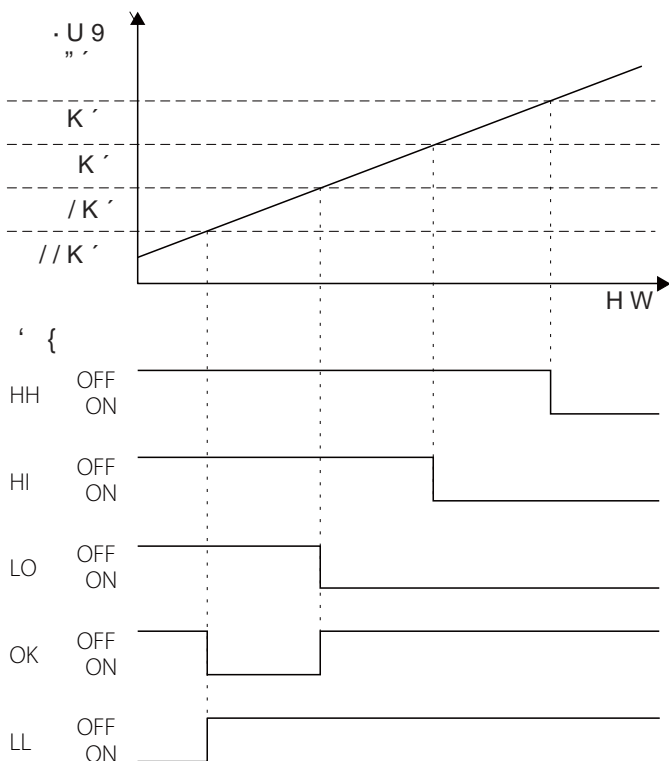

'!Â' LL/LO/HI/OK/HH, Bñ' { s¥ó K
 Øñ' { s¥ó 43= R-„_1FÜ ÜĐâ•L€ZPC Š x° T!Â

7-3. 1 ZT!Â

!Â' Ka/Ka K,,//K¥Hqb

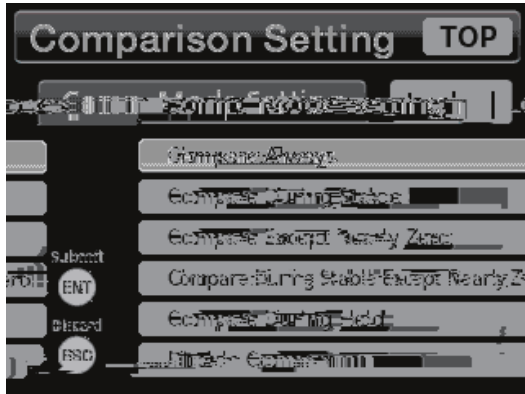

ÿ d

xçùW1 a"áí,Ä-"1 [# "áí,Ä
 -"xçùW1 ¥ •1 ZTĐîÿ•©,,áí
 ,Äÿ?áMM1b
 Wfh• o6-2.îÿ•©p „o7-8.áí,Äp b

7-4. HH LL K' "

!Â^Ž " ì" K,,//K' { b
 ' !Â'î" H |T, K,,//K' { b

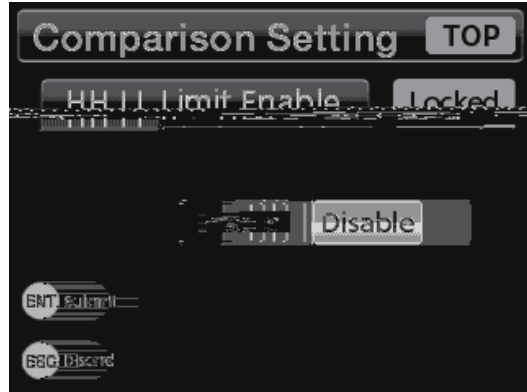

7-5. ì^a

Nÿ?|Bçz @Fž Ka Ka/K,,//K' { M¹
 ÂT·U9"'' B"''_Íoî /î' {
 ô 1 T!Â ì^añîT ÷vÂ/îU?3MÄb
 ÷v ÷ OKÊÂñ KH,['] _µZ_îTb ÷| ÷
 '1 T!Â' LL/LO/OK/Hi/HH ÷ K,, K' ·U9"''h Hì^aµr ÷//K,,/K'
 ·U9"''9FHì^aµrb

OFFñH½ b
 ON,, OFF-WÔNMĐ Øœì^a'V],f ÕÔNMĐb

OKÊÂñ KH,['] _žZ_îTb
 ·U9"''h Hì^aµr ÷//K,,/K'

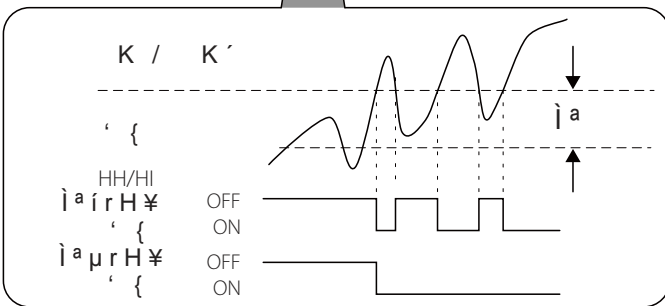
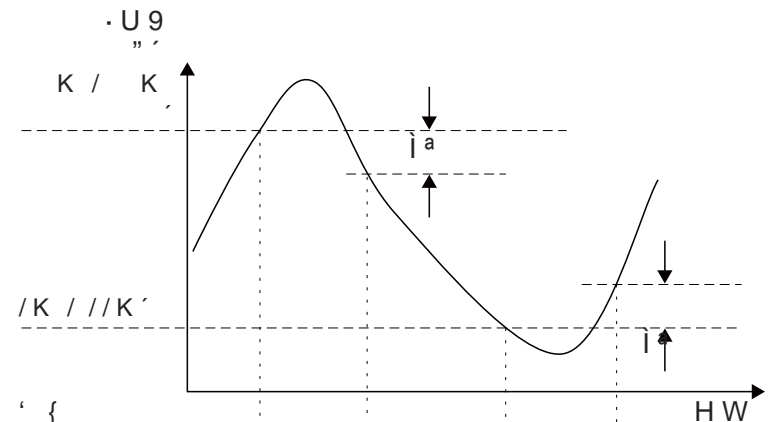
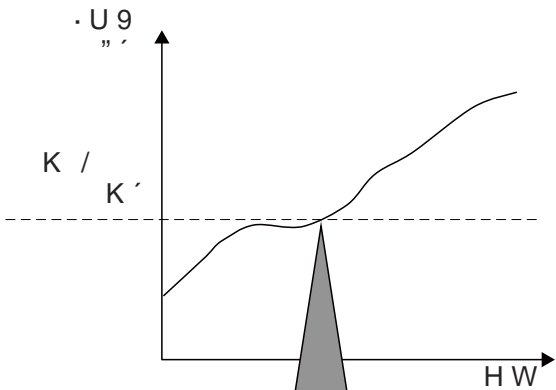

HH/Hi OFF ON
 LL/LO OFF ON

' { Hq '1 { T!Â'S { H

' {	ÿ	Hq	
HH	OFFñ ON	K' < ·U9"''	ÿi h ì ^a !Â'!Â'~+[/Hqb K' < (K' Šì ^a !Â') /K' < (K' Šì ^a !Â') //K' < (/K' Šì ^a !Â')
	ONñ OFF	·U9"'' (K' Šì ^a !Â')	
HI	OFFñ ON	K' < ·U9"''	ÿd o Ka/Ka K,,//K'·"M]ñ ì ^a z !Âb o ÂT!Â'o Op ì"ì ^a b
	ONñ OFF	·U9"'' (K' Šì ^a !Â')	
LO	OFFñ ON	·U9"'' < /K'	
	ONñ OFF	(/K' + ì ^a !Â') ·U9"''	
LL	OFFñ ON	·U9"'' < //K'	
	ONñ OFF	(//K' + ì ^a !Â') ·U9"''	

7-6. ' • |

" / ì" { eÂ•|b

ì" { SÔµr
" Ç ' • |'

ON H ÇE' {

7-7.1 { T

µ Ö' { îT sY'S { „ux{ b

7-7-1. S {

' { îTÂ/
(î^ao 0pH)
HH: K' < .U9"
HI: K' < .U9"
LO: .U9" < /K'
LL: .U9" < //K'

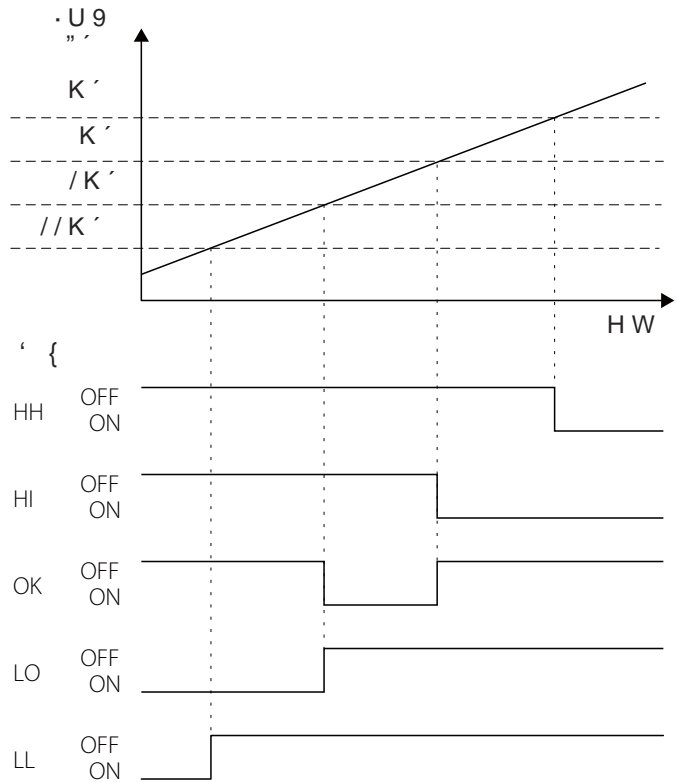

ÿ d

' { îT ô ì^a!Â7MÄbWn»
o7-5. ì^ap b

47 : ¥

7-7-2. u x {

{ îTÂ/

(î^{a1}o 0pH)

HH: K' < .U9'''

HI: K' < .U9''' < K'

LO: //K' < .U9''' < /K'

LL: .U9''' < //K'

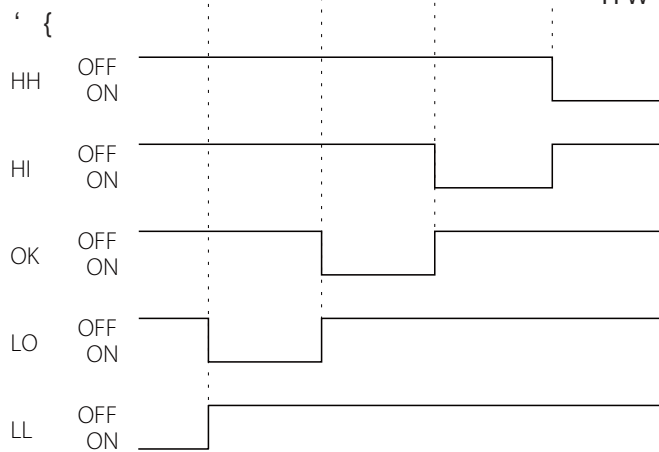
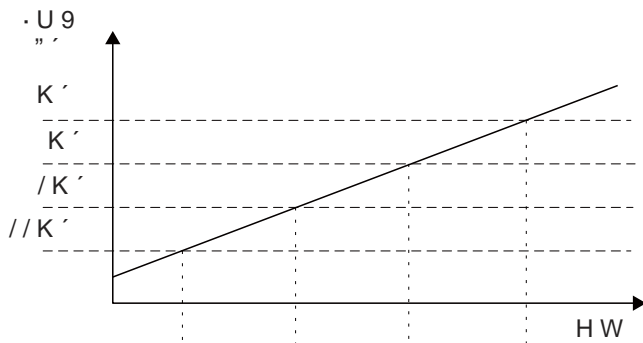

ÿ d

{ îTô ì^a¥!Â7MÄbWn»

47 :¥

o7-5.ì^ap b

7-8. ñÍ, Ä

!Â|.U9'''ç¹ñÍ, Ä¥S¶b

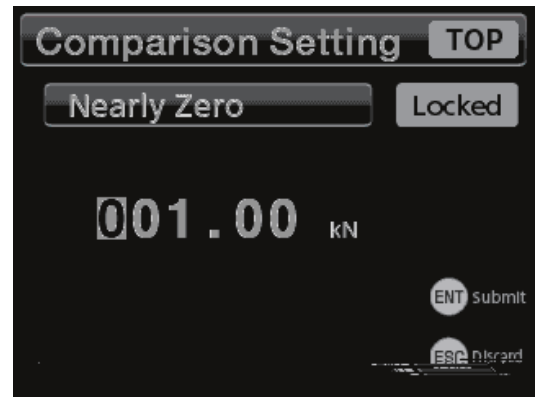

ÿ d

ñÍ, Ä' ²TÐ Ka/Ka K,,//K'

{ áMM1b

Wfh• » 46 :¥o 7-3.1 ZT!Âp b

8. ûÿ?!Â

8-1. û T

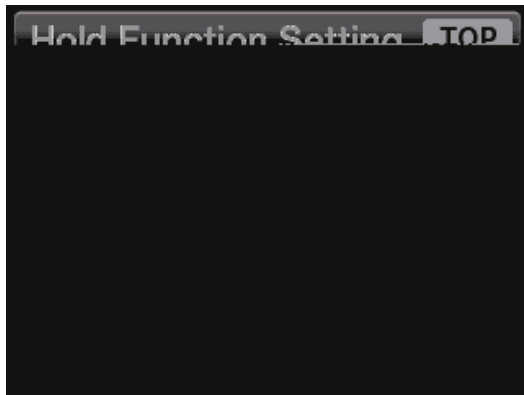
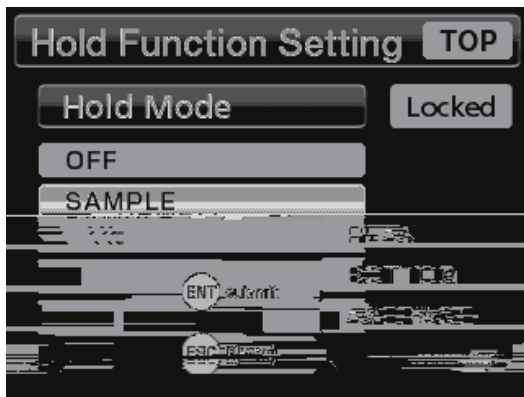

û T µpÕ!Âb
OFF
, û
SAMPLE
•"i û
PEAK
, ' û
BO... OM
! ' û
A E AGE
Ü (' û
PEAK PEAK
, , ' û
PEAK a , d BO... OM
, , " ! ' û

8-1-1. • "i \hat{u}

HOLD $\hat{z} f e \hat{A} \{ \hat{A} E 0 \nexists$ HOLD • | V " $\hat{z} \hat{u} \cdot U 9 "$ ' b
 $\hat{z} B /$ HOLD $\hat{z} f \hat{u} \cdot U 9 "$ ' $\hat{z} B / T, \hat{u} "$ ' b

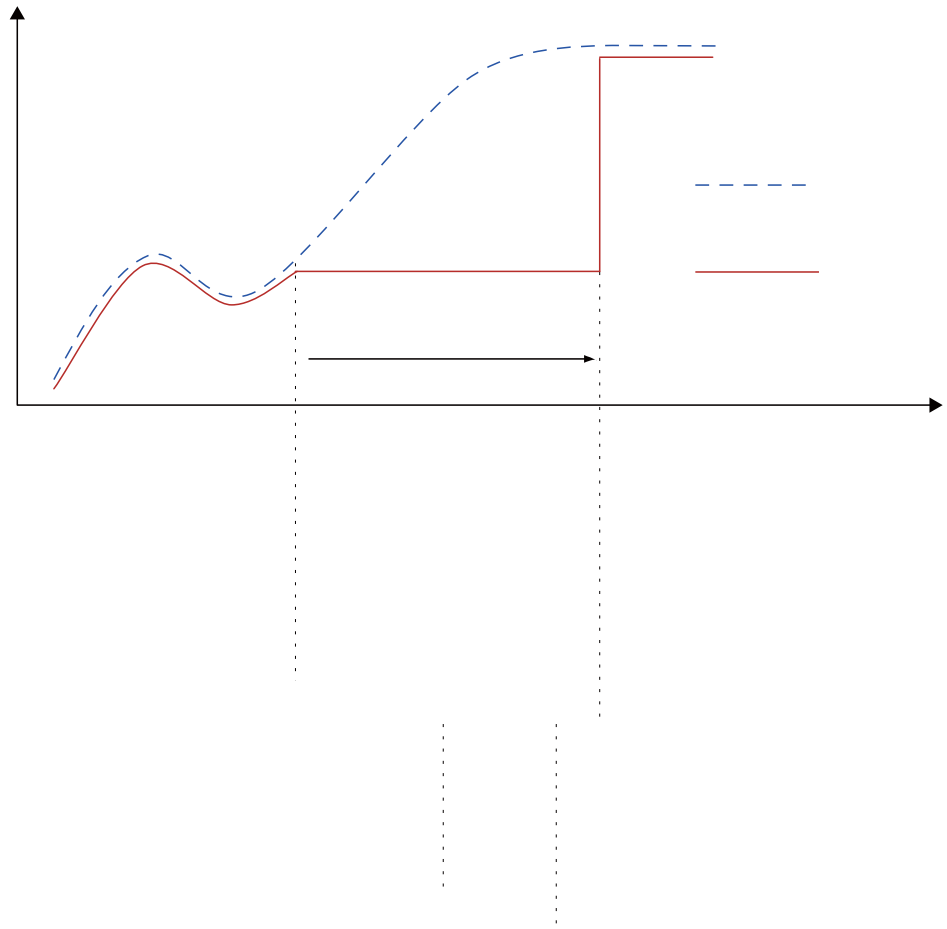

8-1-2-2. P"uxçl

' ûîT>îH |?Ã .U9"´É>AUb

YV¿/ CLEARESC¿f YV|eÅ{Æ 0¥

CLEAR|Mî ONV AUÉ>`Êb

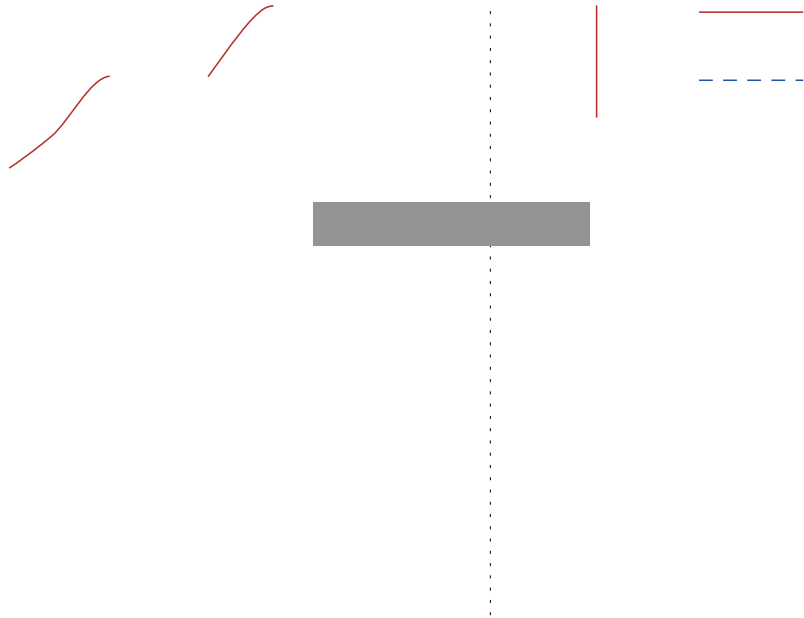

8. ûÿ?!Â

8-1-3. !' û

8-1-3-1. íuxçl

¿ / HOLD ¿ f^a eÂ {Æ 0¥ HOLD • |¹ ON H K@Ä¥ · U9" ' !' É > û b' Q ¿
/ HOLD ¿ f eÂ {Æ 0¥ HOLD • | M¹ OFFH !' û² · b
û H YV ¿ / CLEAR ESC ¿ f YV | eÂ {Æ 0¥ CLEAR • | M¹ ON 9V !' É > - Ê b

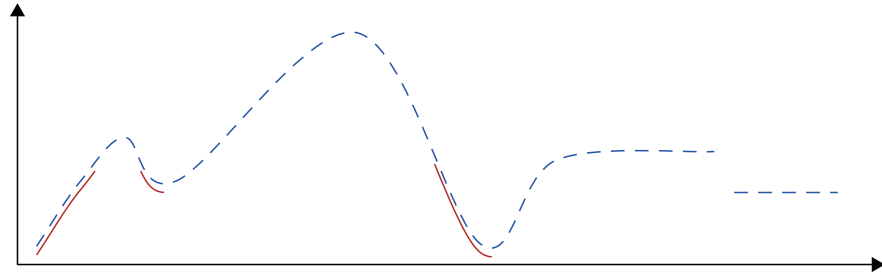

8. üÿ?!Â

8-1-4. Ü(' û

8-1-4-1. íuxçl

ç / HOLD ç f a e Å { Æ 0 ¥ HOLD • | 1 ON H Ü (. U 9 " ' É > û b
 ' Q ç / HOLD ç f e Å { Æ 0 ¥ HOLD • | M 1 OFF H Ü (' û 2 • b
 û H Y V ç / CLEAR ESC ç f Y V | e Å { Æ 0 ¥ CLEAR • | M î ON 9 V Ü (' û É > - Ê b

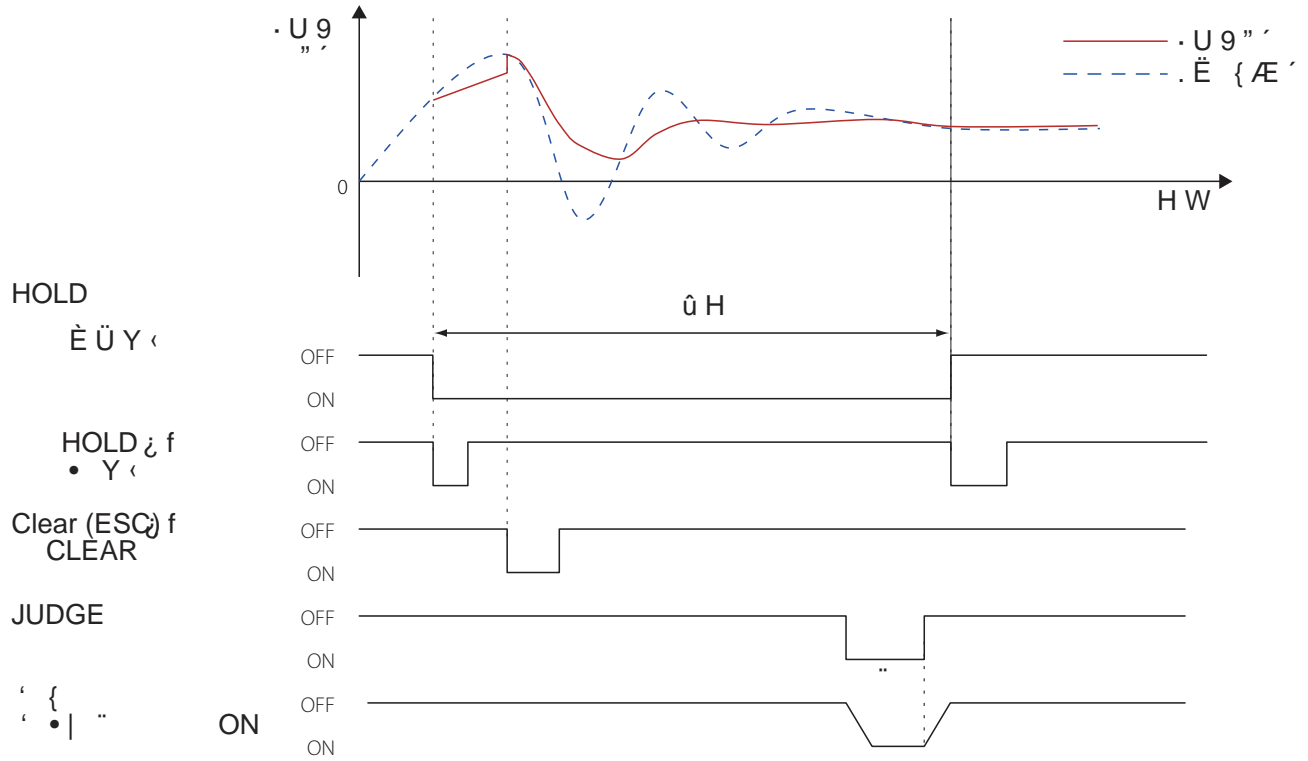

' P HOLD W i ù W Â T Ñ K v Ü (n H W Ü (' û 9 | 2 • b Â T | u x ç ! ! Â 1 ON, Ü (' |
 ¾ Ä \$ û (» 64 :) b

8-1-4-2. P "uxçl

' $\hat{u} \hat{T} \hat{y} \hat{H} | ? \hat{A} \cdot U_9 \text{" 'É} \hat{A} U b$

YV $\hat{z} / \text{CLEAR ESC} \hat{z} f YV | e \hat{A} \{ \hat{A} E 0 \neq$

CLEAR | M \hat{i} ON V A U É } - É b

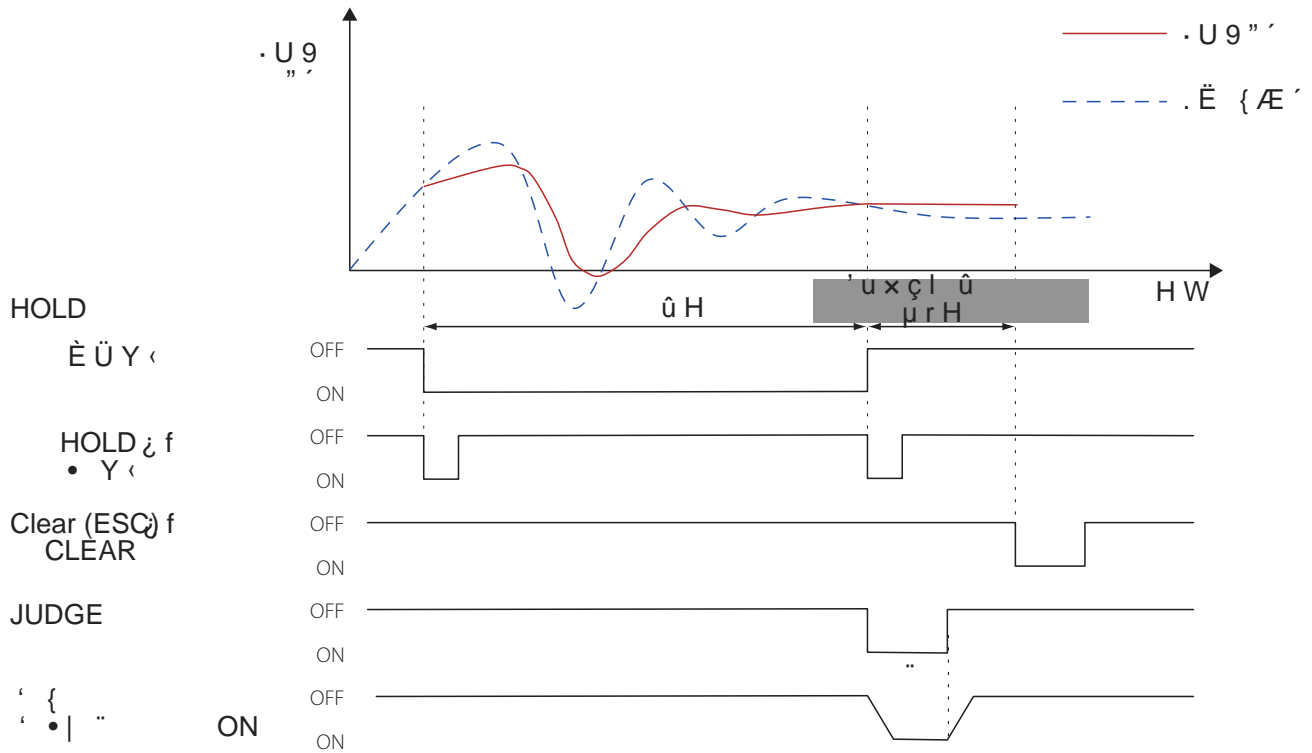

8. ûÿ?!Â

8-1-5. ,,´ û

8-1-5-1. íuxçl

¿/ HOLD¿f^a eÄ{Æ 0¥ HOLD•|¹ ONH ÄQ•"ªû Kv´ ,,´ „KI´ !´ É> û
iO,´Ð!´-W¥Kvµ´|SAU¹·U9"´b´ Q¿/
¹ OFFH ,,´ û²•b
ûH YV¿/ CLEAR ESC¿f YV|eÄ{Æ 0¥ CLEAR•|Mî ON9V ,,´¥ û´É>´Êb

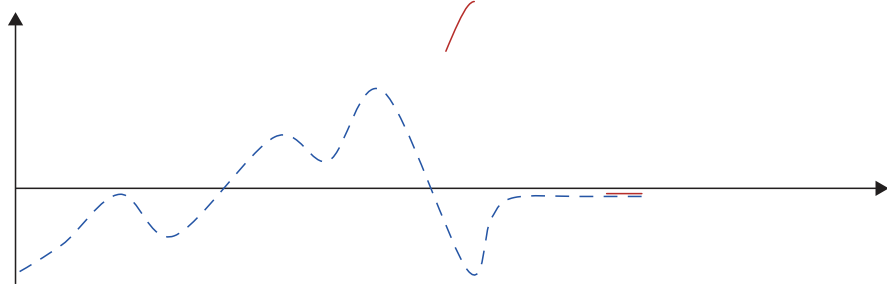

8-1-5-2. P"uxçl

' ûîT>îH |?Ã ·U9"´É>AUb

YV¿/ CLEAR ESC ¿f YV|eÅ{Æ 0¥

CLEAR|Mî ON V AUÉ>´Êb

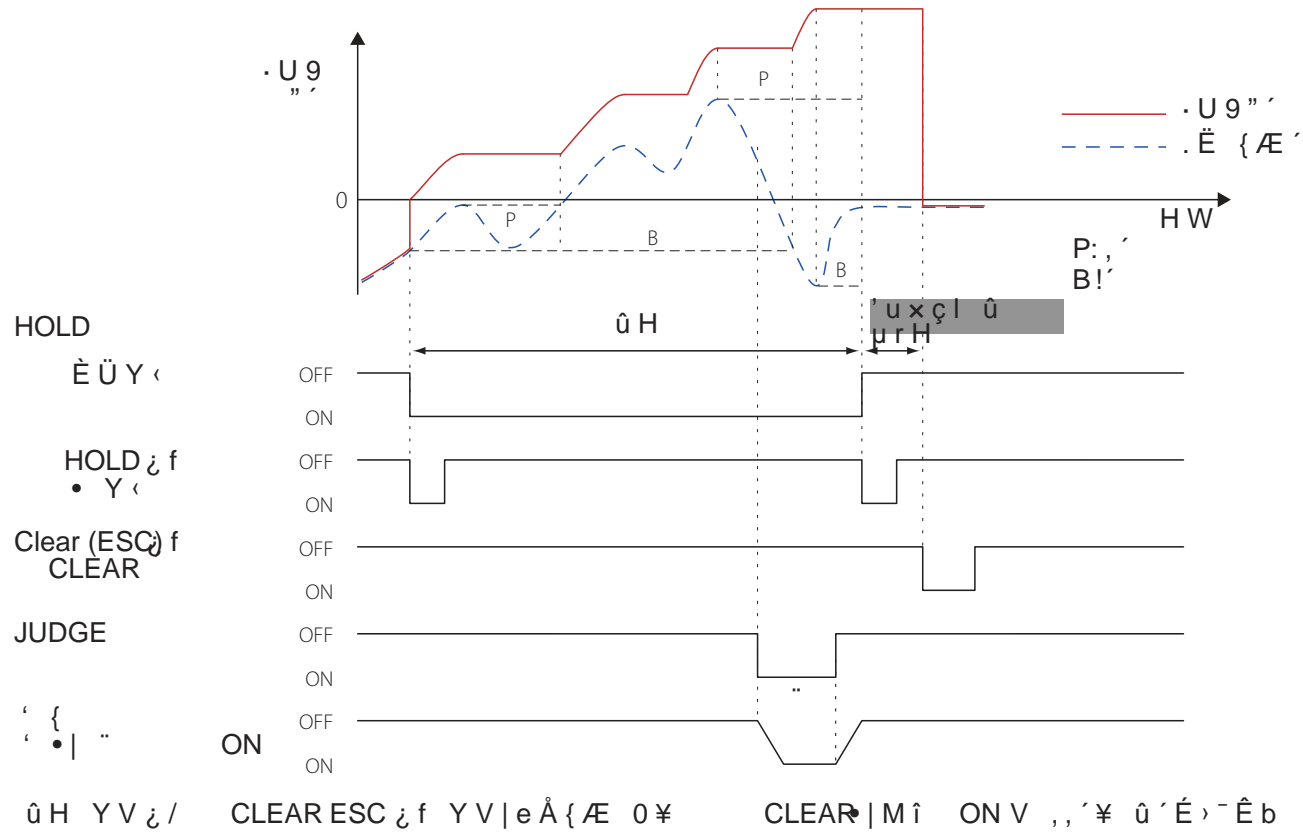

8-1-6. , ' „ ! ' û

8-1-6-1. íuxçl

¿ / HOLD ¿ f^a e Ä { Æ 0 ¥ HOLD • | ' ON H Ä Q • " a û K v ' , ' „ K I ' ! ' É > û
i O û i A U , ' ! ' b
V , ' „ ! ' ^ Ž s Y) ¿ 1 ' S ¶ = É > ' b
' Q ¿ / HOLD ¿ f e Ä { Æ 0 ¥ HOLD • | M¹ OFF H , ' „ ! ' û² • b
û H Y V ¿ / CLEAR ESC ¿ f Y V | e Ä { Æ 0 ¥ CLEAR • | M û ON 9 V , ' „ ! ' É > - Ê b
o ' , ' „ ! ' û µ r H , í , 1 T ! Â ' ' Ö T û | C LL / LO / OK / HI / HH b



8-1-6-2. P " u x ç l

' û î T > î H | ? Ã . U 9 " ' É > A U b

Y V ç / CLEAR ESC ç f Y V | e Å { Æ 0 ¥

CLEAR | M î ON V Ç Ñ U É > ^ | ! ñ U • ð Y ! U p q % | Æ P X ° m C U q Y !

8. ûÿ?!Â

8-1-6-3. ' { Ã M î OK H ÷ U è

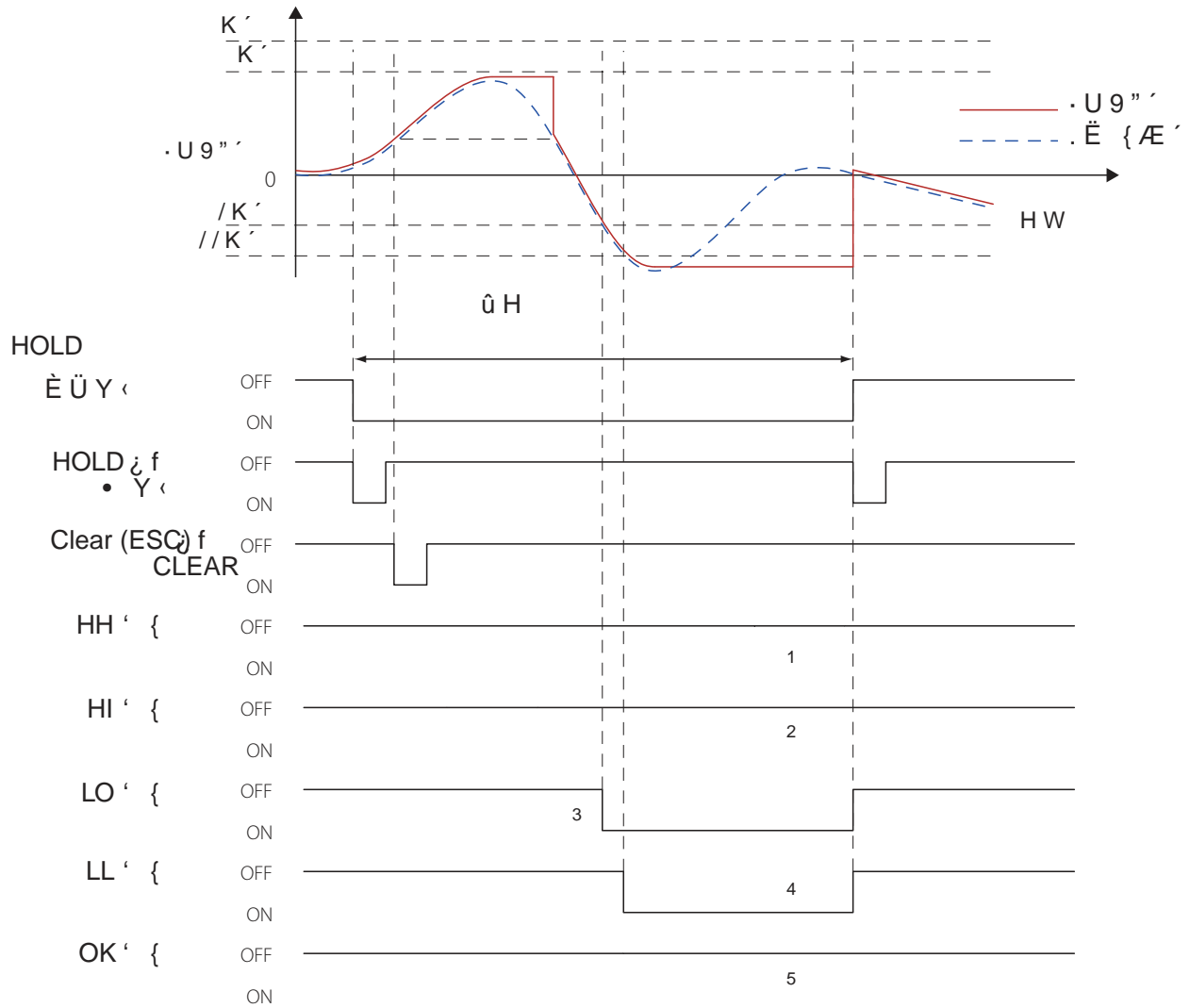

- ¹ ÂT, 'ÃÑV HH HH' { | û OFF ÿb
- ² ÂT, 'ÃÑV HI HI' { | û OFF ÿb
- ³ ÂT! 'l ÷ LO LO' { | M î ONb
- ⁴ ÂT! 'l ÷ LL LL' { | M î ONb
- ⁵ 8 î• , 'ÃÑV HI i O! 'l ÷ LL OK' { | , M î ONb

o ÂT uxçlµr 9 | û' { yNVÆìp ÷ ðyb

8-1-6-4. $HHLLK' \hat{i}'' H\neq U \hat{e}$

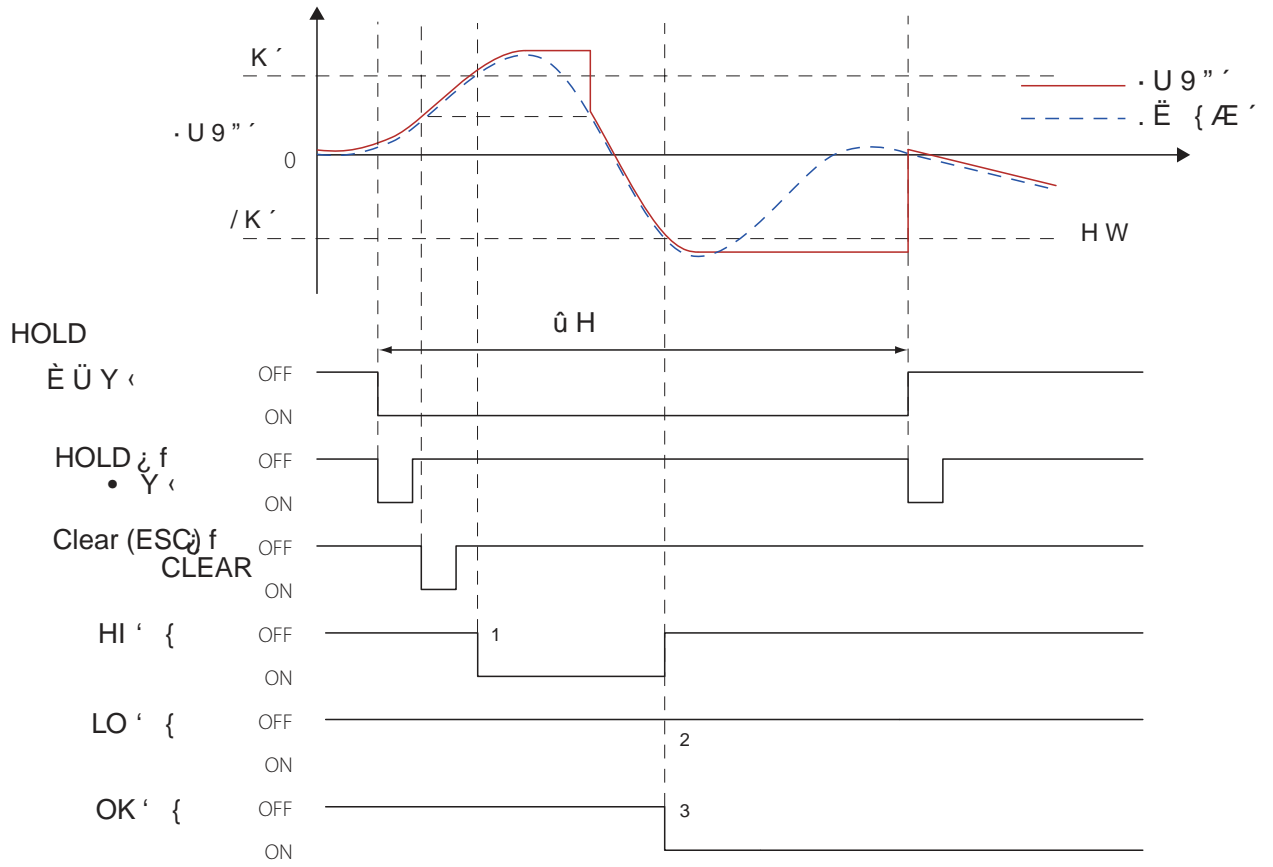

¹ $\hat{A}T, \hat{i}\hat{N}V$ HI HI' { | M \hat{i} ONb

² $\hat{A}T! \hat{i}\hat{e}$ LO OKL

O

8-2. pÜ('¥Q”

'P"Ü(' ûH KvVP"
Ü('b

20000 ñ " ' Ÿ 9 Ø



8-4. “† û T

Ê 4 e Â {Æ 0¥ HOLD • | ì T b

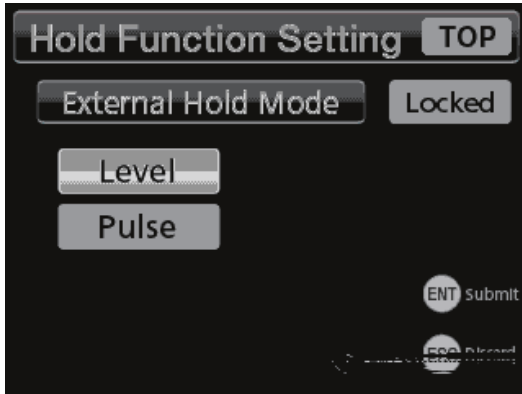

“† û T i [/ Õ Ë ~ b
È Ü
•

8-5. CLEA • |

“ ì “ e Â {Æ 0¥ CLEAR | „ CLEAR (ESC
¿ f b

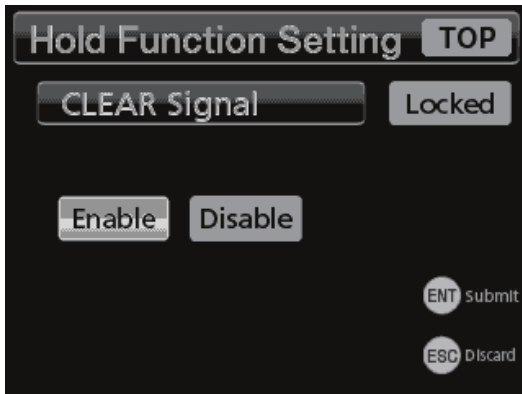

8-6. u x ç |

‘ ! Â ‘ ON H û ² • a | ? Ä . U 9 ” ‘ É ›
A U b
¿ / CLEAR ESC ¿ f CLEAR | | b ” û ¥ ” ‘ b



Ê [ON, OFF

8-7. 1 î , Ä

! Â ‘ û î H ^ Ž 1 î ³ › ” 3 , Ä ÿ ? ON/
OFF b



ON ‘ û î H 1 î ³ › ” 3 , Ä ÿ ?
OFF ‘ û î H , 1 î ³ › ” 3 , Ä ÿ ?

9. " d!Â

9-1. !Âi%

V!çi% ^@“†•|†^@P“N’†mî{
 ÆY’ç [#’YV’†!ÂHÊ4îP“¥i% b
 V i r 4 ñ{µ!Â’¥i% iOñì-W
 VM°MĐb

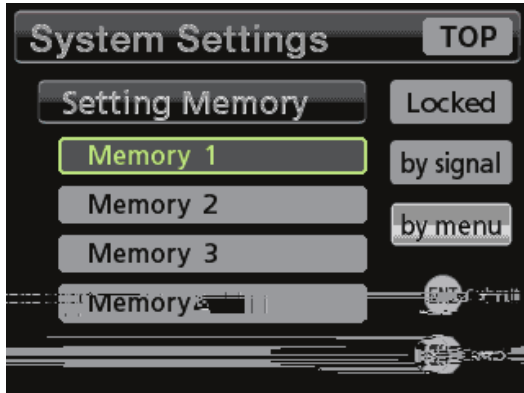

Ê4’-P“¥!Âb
 ÂTXÊ4oYV’†piÉ> ’a MîÊ4i
 ç/ ENTçfY÷ç!Âb
 o ,i !Â’ i F ’†¥ Tb
 o °¤÷çÊç¥i% !Âb
 o íE !Âi% -W-Âb
 ìH i% 1 Âi% 4 û!Â¹ a’b
 h• i% 1 Âi% 4 ïV i¥!Â’¥!Â
 ’ Vb
 ’oYV•|pµrH •” SEL1,, SEL2eÂ{Æ
 09VÊ4i% 1-4b’N!ÂµrH íEV!Â
 ’†îÊ4i% b
 Â³P“”d!Â÷çi% hÊ4oYV’†p b

Ê4oYV • pH		SEL2	
		OFF	ON
SEL1	OFF	i% 1	i% 3
	ON	i% 2	i% 4

ÿd

n ’,?3MÄb

ÿi

o ’oYV•|pµrH |-{ ð•|-^a 100
 ms-=lž¥MĐi% ¥•|b
 o ’ û uxçl ûµrH ’PÊ4oYV•
 |p N!Â9,ö÷çb
 o •Æ!Â’H|Ê÷MĐ¹ OFF,Ç|•Á,:c
 !Â’ 9V?âÊi% b!ÂÄëu7Høì
 M Ê÷b

9-2. D/A Đ

D/A Đ V| < TD-700T.U9”’É> E{
 b
 D/A { Ê^Đ’!!ö8Ê^ïÖb
 E{ S¶¹ 0-•10VÊâ{ 4-20mAÊ @
 { bP“ D/A KvÊâ!Â[1V¥,,É • 1V,,
 •10V-W!ÂKvÊâ{ b
 ô P“ D/A ,Ä,, D/A j ñ¥!Â!Â¥”
 3’VLCV,Ä 0V 4mA Äj ñ • 10V
 20mA ¥ E{ b
 ,Ä,,j ñíEsY¹Ê@{ „Êâ{ É>M
 ÷b
 Đî¹ 4000 Q/ ðb
 ’PÚÍ•”9íEM÷ D/A Đqb
 çÊâ{ hP“µ ÊE,lç 2k\$ ¥“†
 Âõ¤ V-OUT,, COMb
 çÊ@{ hP“µ ÊE cÈ-¤LÈE ,
 vç 350\$ ¥“† Âõ¤ I-OUT,, COMb
 o VP“Êâ{ Ê@{ bíE]H{ Êâ,,
 Ê@b

TD-700T

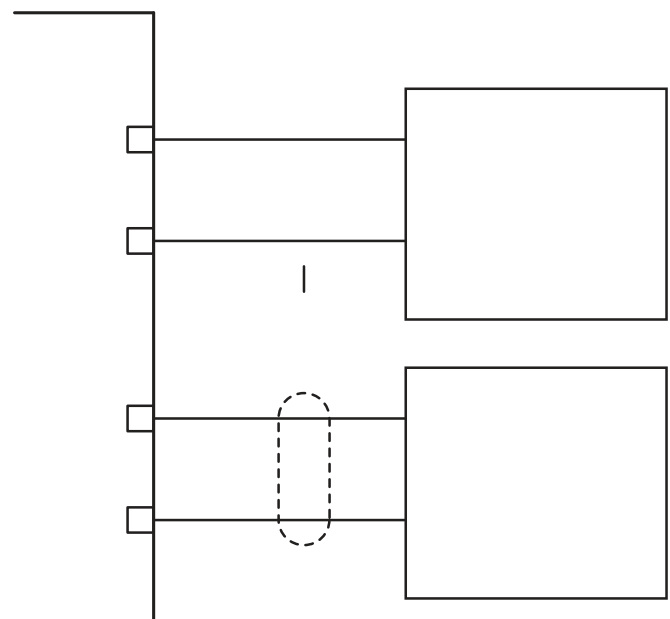

9-2-1. D/A , Ä

!Ä D/A , Ä 0V È â 4mA È @ ³1{ ¥·U
9"´b

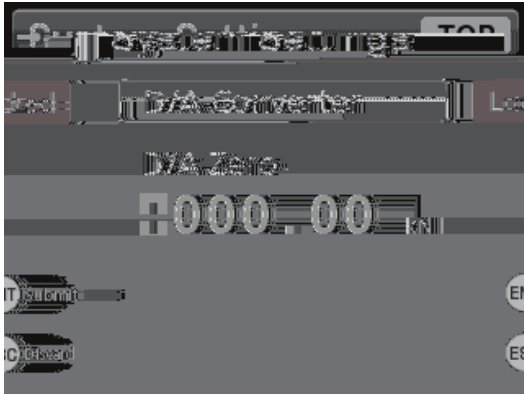

9-2-2. D/A i ñ

•" o9-2-1. D/A, Ä p ´T¹·I , !Ä{ Ä D/A ¥
·U 9"´¥t b
' @ F o9-2-1. D/A, Ä p ,, o9-2-2. D/Ai ñ p !Ä´
H |{ o9-2-4. D/AK v È â p !Ä´È â (´)¿
È @ TH¹ 20 mA)b

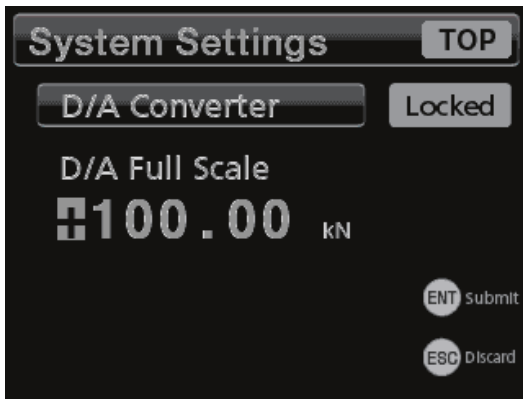

[/¹| o9-2-4. D/AK v È â p !Ä¹ 10 V H¥U è b
!ÄU è 1

D/A , Ä	000.00
D/A i ñ	100.00
·U 9"´	D/A {
100.00	10 V (20 mA)
0.00	0 V (4 mA)
Š100.00	Š10 V(-- mA)

!ÄU è 2

D/A , Ä	020.00
D/A i ñ	100.00
·U 9"´	D/A {
120.00	10 V (20 mA)
20.00	0 V (4 mA)
Š80.00	Š10 V(-- mA)

!ÄU è 3

D/A , Ä	020.00
D/A i ñ	-100.00

9-2-3. D/A { T

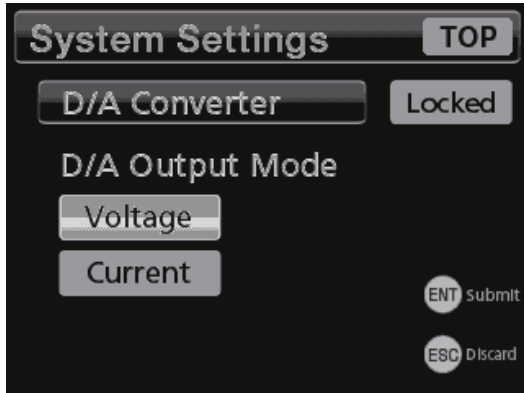

9-2-4. D/A Kv È â

!ÂÈâ K- b
o { ÿµ!Â´ 10 ¥ÑS¶bµ 9P¨M]¥
{ ÈâS¶bèÂ , '!Â´ 5VH, D/Z{ ÈâS
¶|ÿ¹ Š5.5VÀ

9-4.

∅ œ A Ö à ; ¥ b



Ê 4 a ž È a À OFFb

ÿ d

'P!Â' OFF °1 ¿ / ñ ¿ f ; 9 ö [ž È
 Ä 5 ö Ò b
 Ç ; Ä HœV "¿ f T b

9-5. 8ÈHW

!Â, T©... ¿ f ° ž ; 1 > ¥ HW b

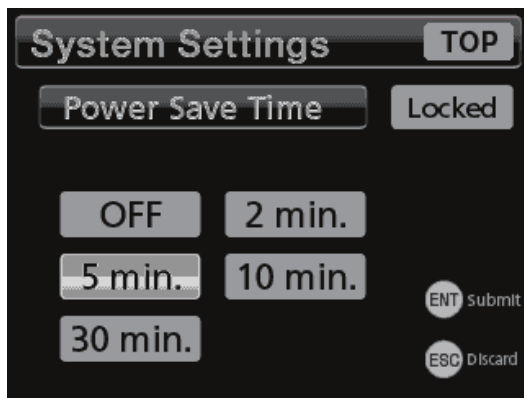

Ê 4 OFF, 2 min., 5 min., 10 min 30 min.

ÿ d

NH¥ •" !Â Ĩ ¥ b
 Ç ; Ä HœV "¿ f T b

9-6. Ô ý

V Ê 4 A U î P " ¥ Ô ý b
 V Ê 4 ° Ô † Ô b

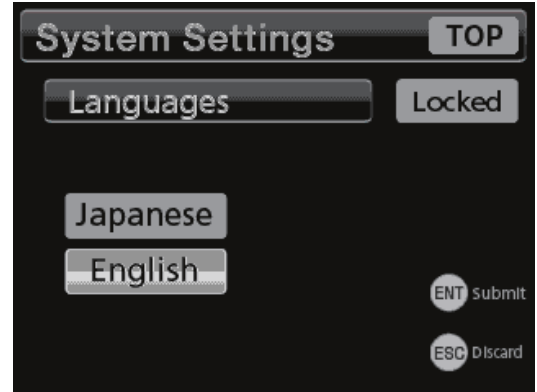

9-7. xÂÀ ì!Â

V |!Â ë -À a ' É › S Ä b

Ê 4 ON -ª ¿ / ENL ¿ f b

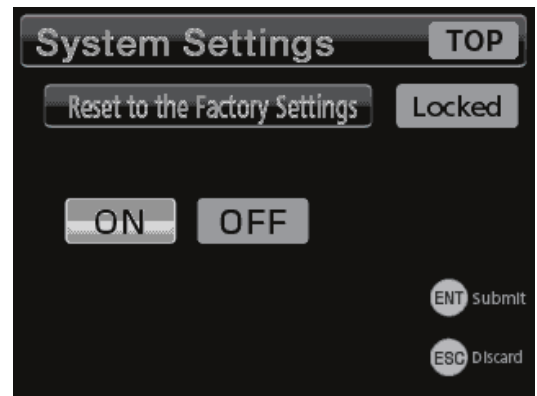

xÂÀ a ' › îª ö Ä ë u 7 b

ÿ d

Ç ' -!Â ¥ i % É › xÂ b
 n ' , É › xÂ b

ÿ i

³ › o xÂÀ ì!Â p 7ª h A 1 > B Q '!! b

10. ED S! Â

Y V | i û IEEE1451.4. È È 0" V TEDS ¥
 . È õ ð ž TD-700T VF i % . È Ĩ ¥ -
 ç { 7 O % - ç { V \$ < " ž ! N ÿ ? ¥ .
 U 9 ¥ n ĩ b
 N " V | TD-700T & ĩ n ¥ " ' F ž TEDS.
 È € V ë ~ S ' b
 N ÿ ? i û TEDS. È Â / i U ¥ ÿ ? b
 Œ ^ h ÿ i ¥ ! TEDS i % ¥ !! c 1kbit „
 4kbit Œ Â Œ TD-700T Ç i û 4kbit b

TEDSS			
IEEE 1451.4 (V0.9)	IEEE1451.4 (V1.0)		
	ð ID		
	È B . È (33)	< M È (35)	ð
-			-
i û TEDS n a TEDS' • Æ „ TEDS' è			
i û TEDS n			
, i û			

10-1. ED S" M ÷

| ' - n ' - ç { „ - ç , [# n ° ù
 • Æ TEDS i % b
 , • Æ • U 9 ¥ † È b

1 ç / FNC ç fu 7 ÿ ? ' † , - a ç " ½ È
 4 ED S! Â ç ED S" M ÷ b

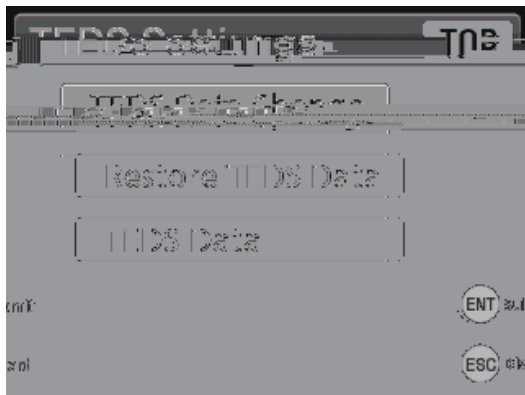

2 { Æ 00015 - a ç Q ENL ç fb

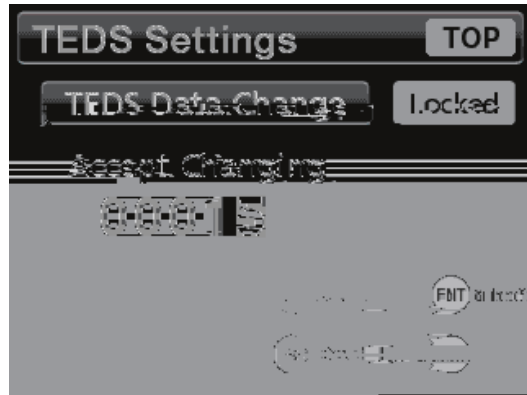

C



ÿ d

o A ¶ { Æ N " '] , i " M ÷ " b
 o ç / ESC ç f | h i | ! Â T b

3 { Æ n ° ù - a ç Q ENL ç fb

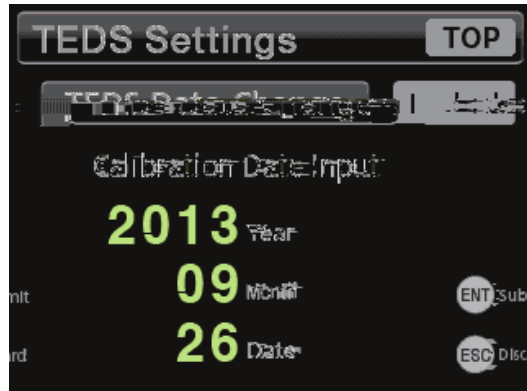

' ž • Æ n " H | Co Writing Cal.
 Datap(ž • Æ n ") b

> ĩ n ' • Æ a | C TEDS! Â i ! z ç
 f { Æ b
 ç / ESC ç f | ! Â T b

10-2. ë - ED S"

P" Nÿ?|.Ë ì a n 'ë-žP" •
TEDS" M ÷ @ ñ î • Æ ¥" b

- 1 ÿ / FNC ÿ fu7ÿ?'† , -a ÿ " ½ Ê
4 ED S! Â q ë - ED S" b

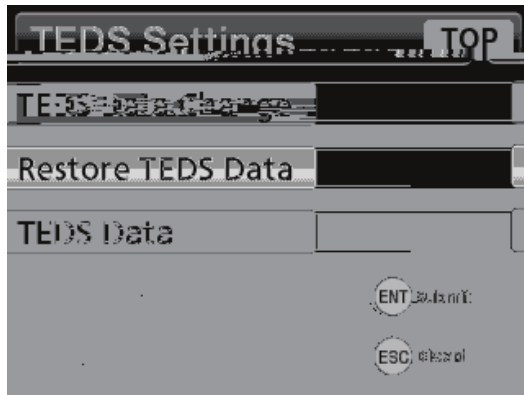

- 2 { Æ o 00015 pb

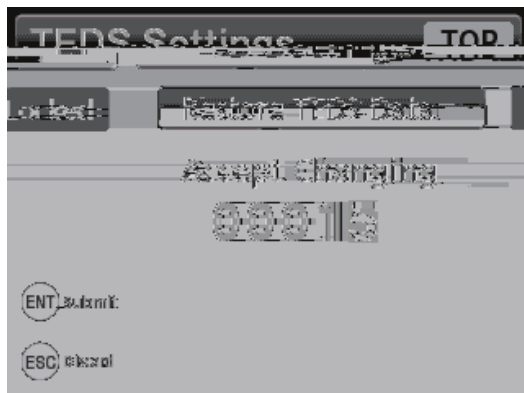

- ÿ d
- o A ¶ { Æ N " '] , i " M ÷ " b
- o ÿ / ESC ÿ f | h i | ! Â T b

- 3 ÿ / ENL ÿ f V - ED S i % ë - " b N
H | C o E e c ' , g p (3 > I) b

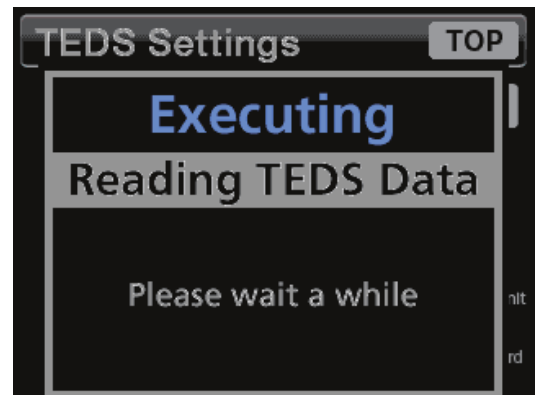

- ÿ î • Æ TEDS i % ë - " a | A U - ç {
(m V / V) , - ç , y N V _ ° N " ' b

- ÿ d
- o ÿ / ESC ÿ f | h i | ! Â T b

- 4 ÿ / ENL ÿ f | " • Æ - ED S i % b N
H | C p ' , g - ED S D a a p (ž • Æ
- ED S ") b

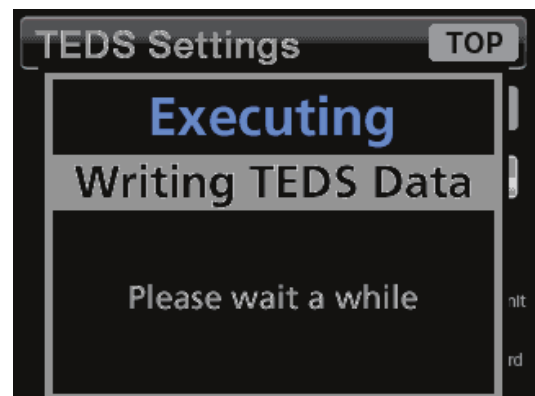

10-3 ED S”

È 4 TEDS” V [° A [/ • ” b
 ½ |
 -ç , ¥ † È
 -ç ,
 -ç {
 È B í q E F
 K v “ † È Ü
 n ° ù

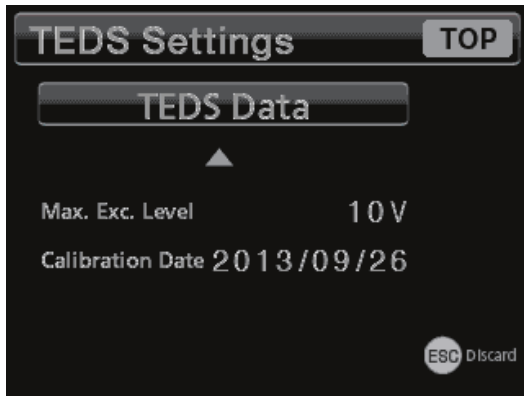
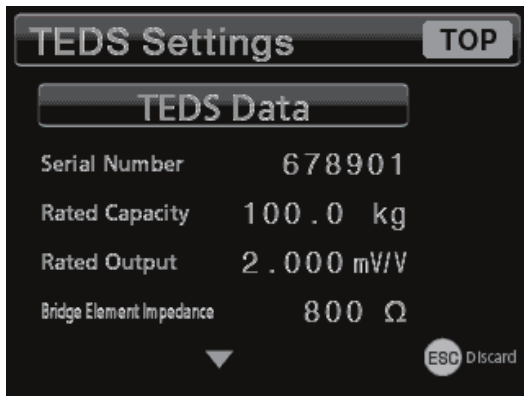

¿ / ESC¿ f | TEDS” A U T b

•	ü
LOAD	" Đ ž Ñ
-LOAD	" Đ μ Ñ
FULL	A U ž Ñ (v ě K v A U ´)
-FULL	A U μ Ñ (l ě K I A U ´)
OVER FULL	{ Æ Ñ V K v { Æ S ¶ (3.2 mV/V)
-OVER FULL	{ Æ l ě K l { Æ S ¶ (Š3.2 mV/V)
ZERO OVER	, Ä Ü™ S ¶ Ñ V ? ç ´
ZERO ERROR	. ç ≠ H W = , Ä Ø œ > ç
OUTPUT CAL OVER	. Ě { Ñ V n S ¶
OUTPUT CAL SHORT	. Ě { Ā r ž n S ¶
MINUS INPUT	. Ě { Æ ´ μ ´
TEDS READ ERROR	Ā õ α μ r ≠ TEDS. Ě
TEDS PW ERROR	î { Æ ≠ á ´ Ð î ! Ā ≠ , }
PARAMETER ERROR	i , † ? S ≠ ! Ā ´
R.O.SET OVER	- ç { Ñ V î ! Ā ≠ S ¶ v ě 3.2 mV/V
R.O.SET SHORT	- ç { © ě î ! Ā ≠ S ¶ l ě 0.3 mV/V
ZEROLIMIT OVER	X Ü Ñ V " 3 , Ā K ´
ERROR	C p
DA OVER	D Ā Ñ { S ¶
DAŠOVER	D Ā Ñ { S ¶
SYSTEM ERROR	C " d p
INVALID OPERATION	T í r

y Î • " T	û T , a A U ² T
, Ä ž Ü™	h © Ě Y
ž ³ › " 3 , Ā	h © Ě Y
ž TEDS"	h © Ě Y
ž • Æ TEDS"	h © Ě Y

12. ?i•”

B â		10V DC, 2.5 V/10% (K v È @ 30mA)
• {Æ S ¶		• 3.2 mV/V
© r {Æ /TEDS	n S ¶	0.3 mV/V...3.2 mV/V
	n Ú	0.1% FS = (' P " 1m É S ° î X ! 8, 350\$ E F4 % à 7 È - , 10VB â „, l ç 0.5mV/V ≠ ! Â H)
Ú	d L Ÿ	0.01% FS = + 1 È (' {Æ, l ç 1 mV/VH)
	, Ä Î M	0.5 0V/°C - = ({Æ Ð ´)
	9 m Î M	• 0.005% FS ° - =
A/D Ð q		4000 Q/ ð
" 3 ro		È 4 3 Hz (Š6db/oct), 10, 30, 100, 300, 1000 Hz (Š12 db/oct)
D/A {		ï Ö ¥ { , [1V 1 „ É ¥ 0 • 1...10 È â { 4...20mÈ @ { 4000 Q/ ð
TEDS Ÿ ?		IEEE1451.Ë Y 2 † T ¶ g
A U		320 x 240' ä A Ö
. U 9 " ´	A U S ¶	Š99999...99999
	l " Ä	V È 4 A U È Â
	A U ¥ Q "	È 4 4, 6, 10 20 Q/ ð
A U ¥ ["	n ! Â	Ä n / ñ n TEDSn L = € n © r {Æ n)
	ÿ ? ! Â	K /K K //K 1 Z T ì a ¶ í, Ä M i Ü (´ ® Y ro î ÿ • © , Ä õ 6 á ÿ ‹ M " 3, Ä , Ä È M u x ç l û T ç o í ç K I W i A U Q " B â " 3, Ä K ´ b " " 3, Ä 1 { T 1 { e Ä È 4 " { D/A Ð
û Ÿ ?		• " ´ û , ´ û ! ´ û „, ´ û „, ! ´ û Ü (´ û u x ç l û , ´ ! ´ „, ´ „ ! ´ Ü (´
" † {Æ „ { •	{Æ	û ´ b " " 3, Ä ! Â i % È 4 1 ! Â i % È 4 2 P " ; È Ò † Ð !!! ö 8 È ^ i Ö
	{	HH, HI, OK, LO, LÈ 7 ^ { (P " ; È Ò † Ð !!! ö 8 È ^ i Ö)
È ÷	œ @ a ¥ È ÷ ? i • ”	- ç Ÿ q DC12V 6W (œ @ a ¥ õ ¶) - ç Ÿ q AC 220 V 10%, 50 Hz, 9 W ç ' ! ! Û , ¥ œ @ a ¥)
	° @ È ÷ ? i • ”	- ç Ÿ q 12...24V DC, 6W
ý T Ñ S ¶		0°...40°
i Ñ S ¶		Š20°...60°
ý T A S ¶		Ú ç 85% RH (ï `)
a " S		CE a £ EN61326 A È
"™ j (W € H € D)		ÿ 96 mm € 53 mm € 132 mm , 9 l p
x		ÿ 300 g

